

# Pavement Condition Report

---

## Sullivan County Airport

Project 16801839

**Prepared for:**

Indiana Department of Transportation  
Office of Aviation  
100 N. Senate Ave.  
Indianapolis, IN 46204

**Prepared by:**

Applied Research Associates, Inc.  
6314 Odana Rd.  
Madison, WI 53719  
(608) 274-6409

**January 2016**





## Executive Summary

### Background

Since 1995, airports have been required to implement a pavement maintenance-management program to receive funding for any project constructed using Federal money. To assist individual airports in meeting this requirement and help improve airport pavement conditions statewide, the Indiana Department of Transportation, Office of Aviation contracted with Applied Research Associates, Inc. to provide pavement evaluation surveys at local airports. This report documents pavement condition at Sullivan County Airport in August 2015.

A primary objective of the pavement management program is to determine maintenance and rehabilitation needs by comparing pavement condition to a standardized benchmark called the minimum service level (MSL), defined as the minimum pavement condition acceptable in managing Indiana’s airfield pavements. The benchmark MSL values used to trigger rehabilitation are shown below.

Runway	Taxiway	Apron
55	50	50

### Pavement Condition

The average inspected Pavement Condition Index (PCI) for all the airfield pavements was 79. The runway had an average inspected PCI of 79 and was above the desired MSL of 55. Taxiways had an average inspected PCI of 73, and ramps had an average inspected PCI of 84.

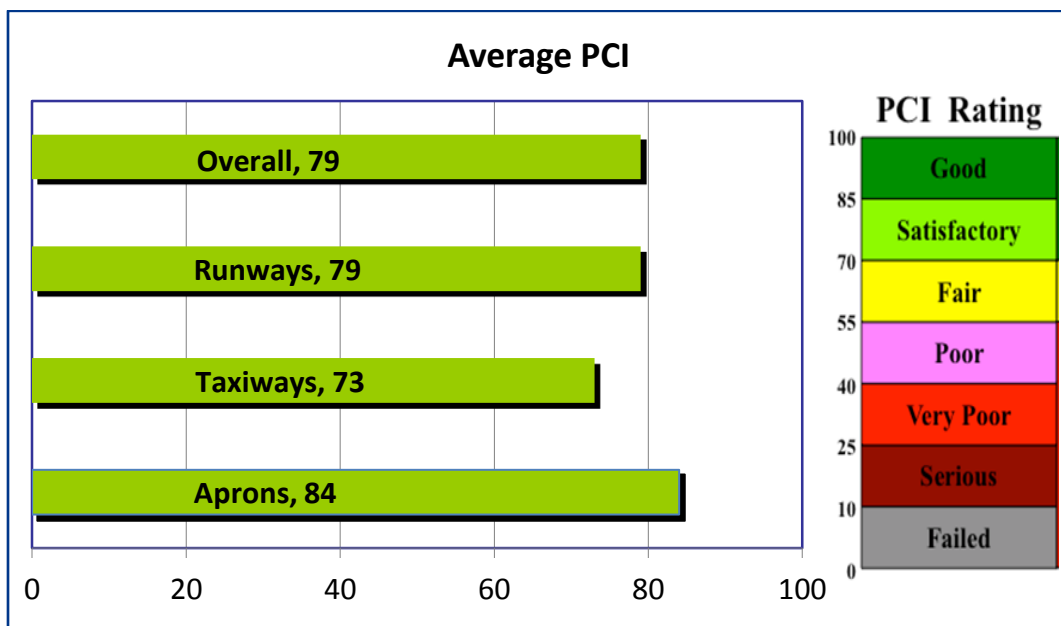

## Capital Improvement Program

The table below provides a summary of the projected pavement rehabilitation needs for the next 5 years of the capital improvement program, starting in 2016. The estimated cost for the rehabilitation actions that provide the greatest increase in pavement service life is approximately \$15,000 in 2016 dollars. If no action is taken, the overall PCI is projected to drop from 79 to 75 by 2020.

Project Year	Calendar Year	Amount
Year 1	2016	-
Year 2	2017	-
Year 3	2018	15,340
Year 4	2019	-
Year 5	2020	-
<b>5-Year Total</b>		<b>15,340</b>

## Maintenance

Analysis of potential maintenance projects identified approximately 4,700 linear feet of crack sealing and crack repair needs, at an estimated total cost of approximately \$5,400.

Specific recommendations to help prioritize airfield maintenance are found in chapter 4 of this report. A summary of all identified maintenance needs is shown in the table below and in the figure on the following page.

Work Item	Quantity	Unit	Cost
AC RESTORATIVE CRACK REPAIR	3,521	LF	\$4,366
AC SUSTAINING CRACK REPAIR	1,180	LF	\$1,022
<b>Total:</b>			<b>\$5,388</b>



AC = asphalt concrete; PCC = portland cement concrete; S.F. = square feet; L.F. = linear feet

# Sullivan County Airport

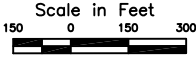
## 2015 PCI Inspection



### Recommended Maintenance

- Patching 
- Crack Sealing 
- Both 

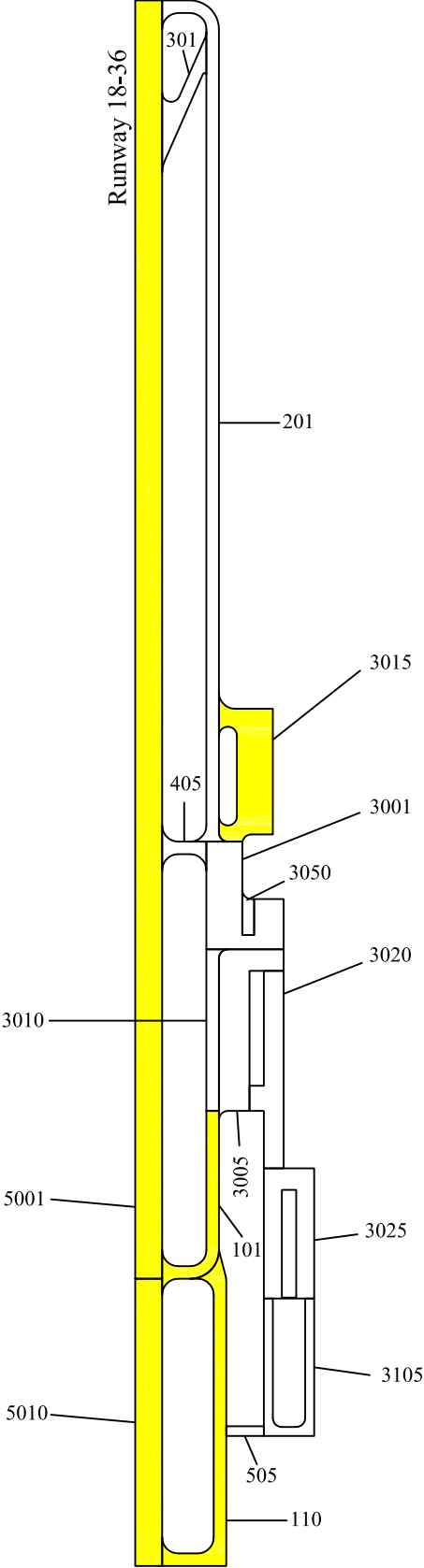

## Table of Contents

---

1. Introduction .....	1
1.1 Objective and Scope .....	1
1.2 Description of Tasks Performed.....	1
2. Pavement Condition Evaluation.....	7
2.1 Overview.....	7
2.2 Distress Types and Frequency .....	11
2.3 PCI Summary.....	12
2.4 Analysis Commentary .....	12
3. Capital Improvement Program.....	15
3.1 Analysis .....	15
3.2 Cost Estimates .....	15
3.3 Capital Improvement Strategies .....	19
4. Maintenance Management Program.....	21
4.1 General Comments .....	21
4.2 Recommended Maintenance Actions.....	21
4.3 Pavement Deterioration .....	24
4.4 Best Practices.....	27
4.5 Pavement Repair Materials .....	30
4.6 Pavement Repair Equipment .....	30
Appendix A. AIRPAV Software.....	33
Appendix B. General Maintenance Techniques.....	35
Appendix C. PCI Summary.....	43
Appendix D. Distress Identification .....	47
Appendix E. Feature Analysis.....	55
Appendix F. Airport Responsibilities.....	93

## Table of Figures

---

Figure 1-1. Pavement Numbering System .....	3
Figure 1-2. PCI Value and Descriptive Rating .....	4
Figure 2-1. Inspected Pavement Condition .....	8
Figure 2-2. Pavement Condition by Branch Use .....	9
Figure 2-3. Typical PCC Pavement in Good Condition (Feature 3050) .....	9
Figure 2-4. Typical AC Pavement in Good Condition (Feature 110) .....	10
Figure 2-5. Typical AC Pavement in Fair Condition (Feature 405).....	10
Figure 3-1. Programmed CIP.....	19
Figure 4-1. Recommended Maintenance .....	23

## Table of Tables

---

Table 1-1. Minimum Service Levels .....	1
Table 1-2. Inspection Density .....	3
Table 2-1. Definition and Distribution of PCI Ratings .....	7
Table 2-2. Distress Frequency in AC Pavement .....	11
Table 2-3. Distress Frequency in PCC Pavement .....	11
Table 2-4. PCI Results .....	12
Table 2-5. Runway Condition Distribution .....	12
Table 2-6. Taxiway Condition Distribution .....	13
Table 2-7. Apron Condition Distribution .....	13
Table 3-1. Unit Costs.....	16
Table 3-2. Most Comprehensive Repair .....	19
Table 3-3. Lowest Annual Cost Repair .....	19
Table 3-4. All Viable Options .....	20
Table 4-1. Recommend Maintenance Actions .....	21
Table 4-2. Recommend AC Restorative Crack Repair.....	22
Table 4-3. Recommend AC Sustaining Crack Repair.....	22
Table 4-4. General Maintenance Policy (AC).....	28
Table 4-5. General Maintenance Policy (PCC) .....	29

## GLOSSARY OF ABBREVIATIONS

AC	- asphalt concrete
AAC	- asphalt overlay on existing asphalt
APC	- asphalt overlay on existing concrete
APMS	- airport pavement management system
ARA	- Applied Research Associates, Inc.
CADD	- computer-aided design and drafting
CIP	- capital improvement program
FAA	- Federal Aviation Administration
FOD	- foreign object damage
GIS	- geographic information system
INDOT	- Indiana Department of Transportation
L&T	- longitudinal and transverse
LTD	- longitudinal, transverse, and diagonal
M&R	- maintenance and rehabilitation
MSL	- minimum service level
PCC	- portland cement concrete
PCI	- Pavement Condition Index
PCN	- Pavement Classification Number
PDF	- portable electronic document



## 1. Introduction

### 1.1 Objective and Scope

The Indiana Department of Transportation, Office of Aviation (INDOT) retained Applied Research Associates, Inc., (ARA) to provide airfield pavement inspection, pavement evaluation, and pavement management services for Indiana’s statewide network of airfield pavements. The pavement evaluations documented in this report were performed under purchase order number 16801839.

A primary objective of INDOT’s ongoing pavement evaluation and management program is to determine maintenance and rehabilitation (M&R) needs by comparing the Pavement Condition Index (PCI) to a standardized benchmark called the minimum service level (MSL). The MSL is defined as the minimum pavement condition acceptable in managing INDOT’s airside pavement. The benchmark MSL values used to trigger rehabilitation vary by airport classification and are shown in Table 1-1.

Table 1-1. Minimum Service Levels

Facility	Primary	Commercial Service	Large GA > 3600’Rwy	Small GA < 3600’Rwy
Runway	70	65	60	55
Taxiway	65	60	55	50
Apron	65	60	55	50

Additional goals of this project were to implement a software program to manage the pavement network, develop performance curves based on historical rates of pavement deterioration, forecast future pavement conditions, identify and recommend specific M&R actions to address the root cause of the documented pavement distress, and estimate the cost and ideal timing of the recommend M&R. The following tasks were performed in support of the project goals:

- Review record documents
- Define the pavement network
- Conduct an airfield condition survey
- Update the AIRPAV database & software
- Develop a 5-year airfield M&R work plan
- Report findings to INDOT

### 1.2 Description of Tasks Performed

#### 1.2.1 Records Review

A detailed records review was performed to determine the airport’s construction history and the as-built cross section for each pavement feature. Plan sets for recent projects were provided to ARA in computer-aided design and drafting (CADD) format. Older plans sets were provided as hard copies or in portable electronic document (PDF) format.

### 1.2.2 Define Pavement Network

Prior to the field survey, a pavement network map was developed using available aerial photography and construction plans. The map was divided into facilities, features, and sample units. A facility is defined as a complete area of the airfield that is used for a particular type of operation. Facilities are typically named for complete functional elements of pavement, such as Runway 11-29, Taxiway A, or North Terminal Apron. After facilities are defined, they are divided into features based on pavement type, construction, structure, and usage. Note that the terms branch and section may be used interchangeably with facility and feature throughout this report.

Features are divided into sample units as prescribed by ASTM D5340-12, *Standard Test Method for Airport Pavement Condition Index Surveys*. A sample unit is a subdivision of a section used exclusively to aid in the inspection process and reduce the effort needed to determine distress quantities and the PCI. The specified sample unit size for an asphalt concrete (AC) pavement is  $5,000 \text{ ft}^2 \pm 2,000 \text{ ft}^2$ . Sample units on portland cement concrete (PCC) pavements contain  $20 \pm 8$  slabs.

To allow users to search, sort, and identify airport pavement quickly, a numbering system is used in conjunction with the facility, feature, and sample unit convention. The format starts with facility, then feature, and finally identifies the sample unit. The number 1605.300 is parsed as an example in Figure 1-1. Most pavement references in this report are presented in this format.

Using statistical sampling methods, the PCI procedure provides a high confidence level in evaluating overall pavement condition while sampling only a portion of the pavement surface. Table 1-2 shows the network-level inspection density used on this project. Where appropriate, “additional sample units” were identified and inspected to record pavement areas with distress patterns not representative of the overall pavement condition. The unique distress types documented in additional sample units are not extrapolated across the entire feature.

As the surveyors inspected the pavement, they were mindful to ensure that the pre-survey airfield map depicted the actual pavement, otherwise known as a “ground-truth” survey. Noticeable differences between what was present in the field and what was displayed on the maps were adjusted by a CADD technician.

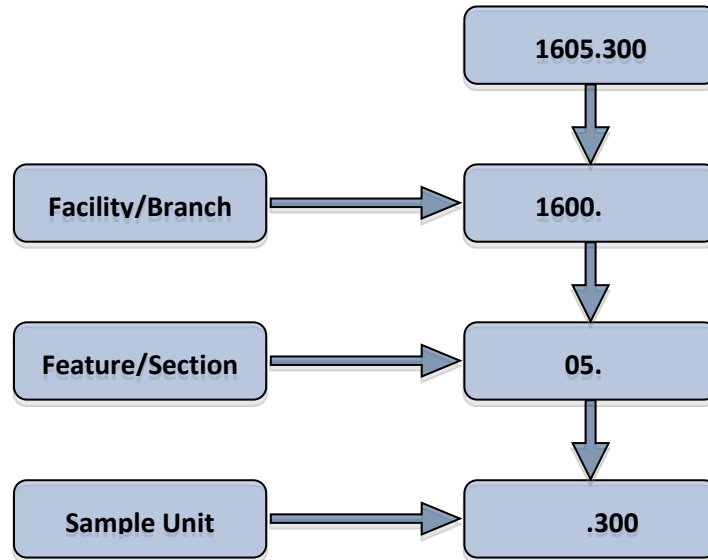

Figure 1-1. Pavement Numbering System

Table 1-2. Inspection Density

Sample Unit in Feature	Inspected Sample Units
1-2	ALL
3-4	2
5-7	3
8-10	4
11-14	5
15-19	6
20-25	7
26-30	8
31-37	9
38-45	10
46-55	11
56-80	12
> 80	15%

### 1.2.3 Conduct Airfield Condition Survey

The pavement condition surveys were performed in accordance with ASTM D5340-12. The procedure is based on the identification and measurement of visible distress at the pavement surface. Each PCI distress will deduct from the pavement's perfect condition of 100. Using pavement management software (or curves provided in ASTM D5340-12), a deduct value is determined for each combination of distress type, severity, and measured quantity. The PCI value is then determined from the unique combination of these variables.

A primary benefit of the PCI procedure is the ability to perform objective evaluations and compare pavement condition with an easy-to-understand numerical rating. Because the combined impact of multiple distresses is not cumulative, ASTM D5340-12 provides an additional family of curves to adjust for multiple distresses. The PCI is determined by applying the individual deduct value for each distress type along with any required correction factors to account for multiple distress types.

Figure 1-2 shows the relationship between PCI values and descriptive ratings. Generally, pavement maintenance is most cost-effective when the pavement is still in satisfactory condition. Rehabilitation, such as an asphalt mill and inlay, is typically performed for pavements with PCI values between 55 and 70. When the PCI value drops below 55, a mill an inlay may not provide the desired performance and complete reconstruction often becomes the most cost-effective means of repairing the pavement.

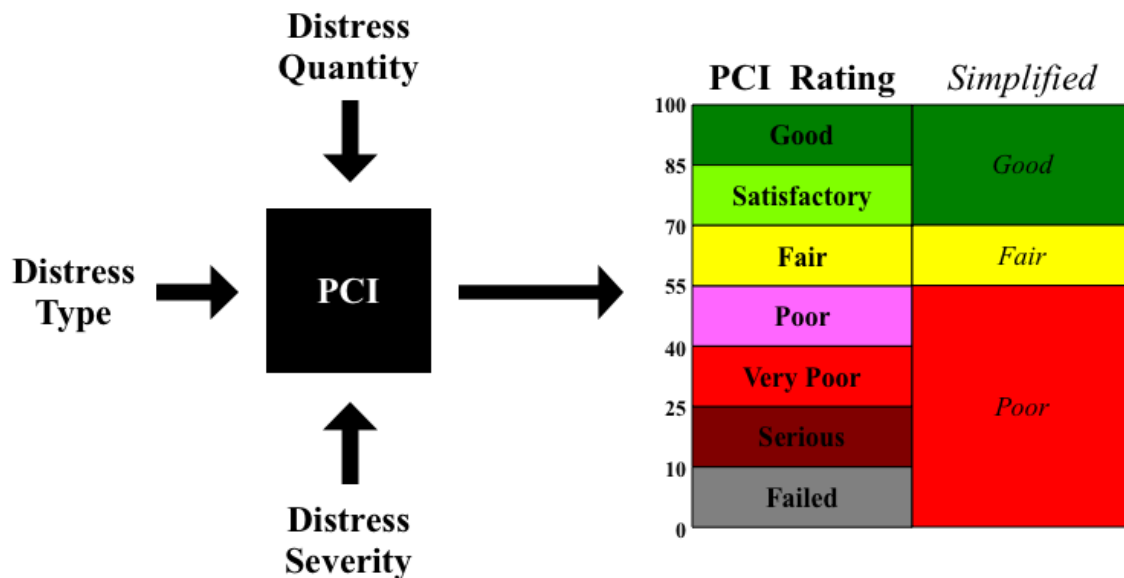

Figure 1-2. PCI Value and Descriptive Rating

#### **1.2.4 Update AIRPAV Database & Software**

The network definition, construction history, and data from the survey were entered into the AIRPAV pavement management system (APMS) software. After all data were entered, family curves were developed to model the change in pavement condition over time. These family curves are used to estimate future pavement condition. Typically, several curves are developed, with separate curves defined for different pavement surface types, such as AC, PCC, asphalt overlay on existing asphalt (AAC), and asphalt overlay on existing concrete (APC). The latest version of AIRPAV containing all survey data, deterioration curves, M&R policies, budgets, and construction history, was provided to INDOT on CD-ROM.

#### **1.2.5 Develop 5-Year Airfield M&R Work Plans**

A 5-year capital improvement program (CIP) was developed showing the year that each pavement feature was expected to fall below the MSL. The 5-year plan detailed in chapter 3 shows rehabilitation alternatives for each feature based on the PCI and the individual distress types observed during the pavement evaluation. The timing of each project is shown as the year that the PCI falls below the MSL and does not consider other important factors. Using reports like this for each airport in the State, INDOT engineers and planners develop a final 5-year statewide CIP plan that balances the sometimes conflicting priorities of pavement condition, operational constraints, construction staging considerations, and available funding.

#### **1.2.6 Report Finding to INDOT**

This report includes background information, PCI results and recommendations, and M&R budget scenarios. Photographs depicting typical pavement conditions observed during the survey are included in chapter 2. Appendix A contains general information about the AIRPAV pavement management software. Appendix B contains a summary of general maintenance techniques and best practices. Appendix C provides a detailed summary of the airfield pavement condition. Appendix D describes common airfield distress types. Appendix E provides an analysis of each pavement section based on recorded distress, and Appendix F contains exhibits to help the airport owner manage the airfield pavement system.

This page intentionally left blank

## 2. Pavement Condition Evaluation

### 2.1 Overview

Approximately 740,000 ft<sup>2</sup> of total airside pavement is represented herein. Using statistical sampling methods approximately 230,000 ft<sup>2</sup> of AC pavement and 14,000 ft<sup>2</sup> of PCC pavement was surveyed as part of this assessment. The average inspected PCI for all pavements was 79 (Satisfactory). The average inspected PCI for the runways, taxiways, and ramps were as follows: 79 (Satisfactory), 73 (Satisfactory), and 84 (Satisfactory). Table 2-1 provides a general description of the PCI rating categories, including a simplified rating scale of Good, Fair, and Poor. This table also shows the associated distress levels and general M&R requirements for each rating category.

Table 2-1. Definition and Distribution of PCI Ratings

Simplified PCI Rating	PCI Range	Definition	Pavement Area (ft <sup>2</sup> )	Pavement Area (%)
Good	86-100	GOOD: Pavement has minor or no distresses and requires only routine maintenance.	105,498	14%
	71-85	SATISFACTORY: Pavement has scattered low-severity distresses that need only routine maintenance.	515,299	69%
Fair	56-70	FAIR: Pavement has a combination of generally low- and medium-severity distresses. M&R needs are routine to major in the near future.	123,634	17%
Poor	41-55	POOR: Pavement has low-, medium-, and high-severity distresses that probably cause some operational problems. Near-term maintenance and repair needs may range from routine up to a requirement for reconstruction.	-	0%
	26-40	VERY POOR: Pavement has predominantly medium- and high-severity distresses that cause considerable maintenance and operational problems. Near-term maintenance and repair needs will be intensive in nature.	-	0%
	11-25	SERIOUS: Pavement has mainly high-severity distresses that cause operational restrictions; immediate repairs are needed.	-	0%
	0-10	FAILED: Pavement deterioration has progressed to the point that safe operations are no longer possible; complete reconstruction is required.	-	0%

The pavement within each of the PCI condition categories is shown in Figure 2-1. The inspected PCI is summarized by branch use in Figure 2-2, and the photographs in Figure 2-3 through Figure 2-5 provide examples of the condition categories.

# Sullivan County Airport

## 2015 PCI Inspection

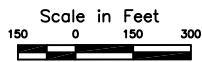

### PCI LEGEND

100-86	Good	
85-71	Satisfactory	
70-56	Fair	
55-41	Poor	
40-26	Very Poor	
25-11	Serious	
10-0	Failed	

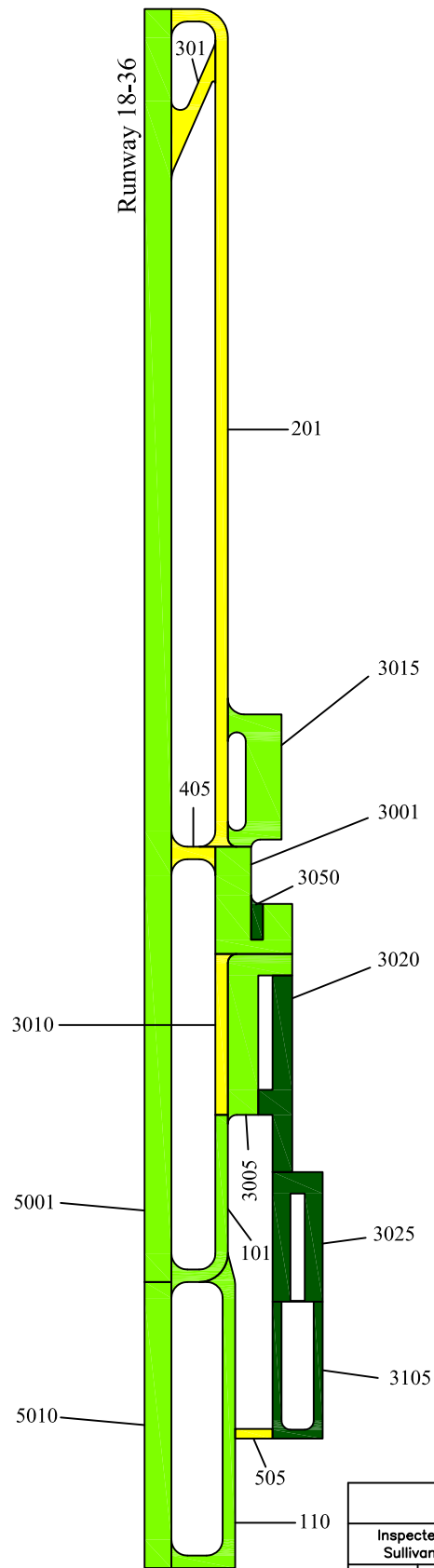

Inspected Pavement Condition Sullivan County Airport (SIV)			
ENGINEER: BDA	DRAWN BY: JCB	DATE: Jan 2016	CTAF 122.8

Figure 2-1. Inspected Pavement Condition at Sullivan County Airport (SIV).



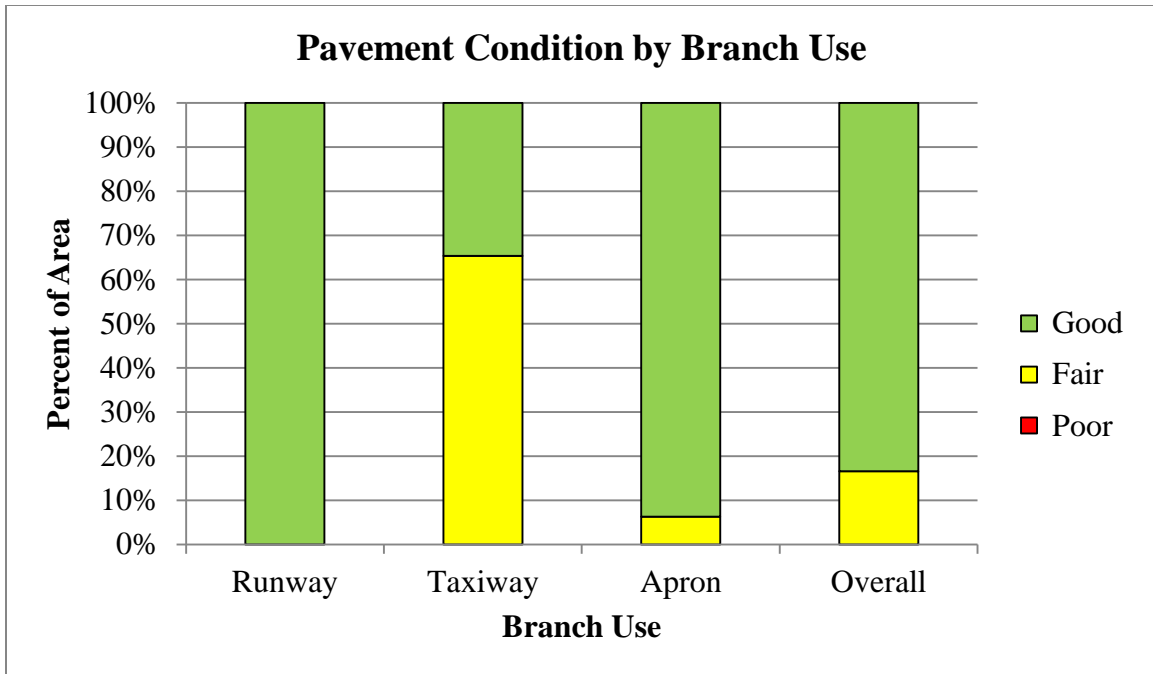

Figure 2-2. Pavement Condition by Branch Use



Figure 2-3. Typical PCC Pavement in Good Condition (Feature 3050)



Figure 2-4. Typical AC Pavement in Good Condition (Feature 110)



Figure 2-5. Typical AC Pavement in Fair Condition (Feature 405)

## 2.2 Distress Types and Frequency

The inspectors surveyed approximately 230,000 ft<sup>2</sup> of AC pavement. The frequency of each distress type is shown in Table 2-2. The recorded distress types were longitudinal and transverse (L&T) cracking, patching, swell, depressions, raveling, alligator cracking and block cracking. L&T cracking and block cracking are age-related distresses. Alligator is a load-related distress.

Table 2-2. Distress Frequency in AC Pavement

Distress	Sample Units	% Inspected Sample Units
L&T CRACKING	56	92
WEATHERING	26	43
PATCHING	7	12
SWELL	6	10
DEPRESSIONS	5	8
RAVELING	3	5
ALLIGATOR CRACKING	2	3
BLOCK CRACKING	1	2

The inspectors surveyed approximately 14,000 ft<sup>2</sup> of PCC pavement. The frequency of each distress type is shown in Table 2-3. The recorded distress types were corner breaks, LTD cracks, and shrinkage cracks.

Table 2-3. Distress Frequency in PCC Pavement

Distress	Sample Units	% Inspected Sample Units	Slabs	% Inspected Slabs
CORNER BREAK	1	25	3	3
LONG/TRANS/DIAG CRACKS	1	25	3	3
SHRINKAGE CRACKS	1	25	1	1

## 2.3 PCI Summary

The branch and section PCI values are shown below, along with the surface type, area, and last year construction occurred.

Table 2-4. PCI Results

Branch ID	Branch PCI	Section	Surface	Area (sf)	Built	2012 PCI	2015 PCI
100	79	101	AC	20,600	2004	84	77
		110	AC	36,515	2002	86	80
200	70	201	AC/AC	86,356	2004	79	70
300	70	301	AC/AC	12,932	2004	78	70
400	68	405	AC/AC	5,600	2004	82	68
500	69	505	AC	2,862	2011	100	69
3000	83	3001	AC	42,800	2004	89	78
		3005	AC	43,950	2004	83	73
		3010	AC/AC	15,884	2004	76	70
		3015	AC	41,000	2000	74	72
		3020	AC	33,050	2012	100	100
		3025	AC	50,760	2011	100	96
		3050	PCC	3,434	2000	86	85
3100	100	3105	PCC	21,688	2009	100	100
5000	79	5001	AC	267,000	2004	81	79
		5010	AC	60,000	2000	83	80

## 2.4 Analysis Commentary

The following pages provide a brief overview of the 2015 inspected pavement conditions for each facility. Comments are based primarily on the AIRPAV analysis but also include field notes and remarks from the pavement condition inspectors. Where appropriate, individual pavement sections are referenced within the larger facility.

### 2.4.1 Runways

The runway consisted of two sections of AC pavement. The runway had a total area of 327,000 ft<sup>2</sup> with an area-weighted average PCI of 79 (Good). L&T cracking and patching were the most common recorded distress. The distribution of runway pavement by PCI range is shown in Table 2-5.

Table 2-5. Runway Condition Distribution

PCI Range	Rating	Number of Sections	Pavement Area (ft <sup>2</sup> )	Pavement Area (%)
100-71	Good	2	327,000	100%
70-56	Fair	-	-	0%
55-0	Poor	-	-	0%

### 2.4.2 Taxiways

The taxiways consisted of six sections of AC pavement. The total area of the taxiways was 164,865 ft<sup>2</sup> with an area weighted average PCI of 73 (Good). L&T cracking and weathering were the main distresses for the taxiway in (Good) condition. The taxiway pavement in (Fair) condition had some added depression. Taxiway pavement distribution by PCI range is shown in Table 2-6.

Feature 505 is called out for additional discussion due to a 31 point decrease in PCI from the prior survey. This large decrease is due to the appearance of 116 square feet of depression. Because this is a small feature of approximately 3,000 square feet, the impact of the depression isn't being averaged out over a larger area thus has an outsized impact on the PCI.

Table 2-6. Taxiway Condition Distribution

PCI Range	Rating	Number of Sections	Pavement Area (ft <sup>2</sup> )	Pavement Area (%)
100-71	Good	2	57,115	35%
70-56	Fair	4	107,750	65%
55-0	Poor	-	-	0%

### 2.4.3 Aprons

The aprons consisted of five sections of AC pavement and two sections of PCC pavement. The total area of apron pavements was 252,566 ft<sup>2</sup>, and the area-weighted average PCI was 84 (Good). The distribution of apron pavement by PCI range are shown in Table 2-7.

Table 2-7. Apron Condition Distribution

PCI Range	Rating	Number of Sections	Pavement Area (ft <sup>2</sup> )	Pavement Area (%)
100-71	Good	6	236,682	94%
70-56	Fair	1	15,884	6%
55-0	Poor	-	-	0%

This page intentionally left blank

### **3. Capital Improvement Program**

---

#### **3.1 Analysis**

The individual feature analyses shown in appendix E document viable rehabilitation projects that address the causes of each pavement section's distress while restoring the pavement to a condition above the desired MSL. The recommended timing of each improvement action is defined as the year that the pavement condition is projected to reach the MSL. By establishing benchmark MSL targets, it is possible to plan objectively for future needs against a standard set of performance criteria. This section categorizes the identified viable options into CIP strategies based on cost and expected service life.

The airport may find it desirable to adjust the timing of projects detailed in the CIP to meet fiscal and operational constraints. For example, if different sections of a runway were projected to reach the MSL in various years ranging from 2016 to 2018, it is not operationally feasible to stage rehabilitation over a 3-year period. Instead, runway rehabilitation would be programmed in a manner that balanced the need to minimize the length of the runway closure while maximizing the remaining service life.

#### **3.2 Cost Estimates**

Project costs were estimated based on the pavement area and the unit costs shown in Table 3-1 for specific M&R activities. Project costs are presented so planners and managers can compare the relative magnitude of funding required for various alternatives. The two-page AIRPAV feature analysis (see appendix E) provides cost estimates for each identified project. These cost estimates are for planning purposes only and do not constitute an engineering estimate.

Furthermore, these cost estimates represent the improvement of existing pavement structures and associated incidental work only. Other potential project line items, such as lighting, navigational aids, and drainage modifications are not included, and estimates for those items must be developed separately and incorporated into an overall project cost.

Typical examples of work that might be included in alternatives evaluated by AIRPAV are outlined on the following pages. These example projects would meet the requirements for each selected option; however, the descriptions are not intended to imply required, or even preferred, design configurations. Rehabilitation decisions, such as overlay thickness design, should be made in conjunction with engineering design analysis.

Table 3-1. Unit Costs

Rigid Pavement (PCC)	
Reconstruction	\$12.90 /sf
Slab Replacement & Full Depth Patching	\$12.48 /sf
Patching (Partial Depth)	\$16.70 /sf
Slab Repair & Overlay	\$4.69 /sf + \$0.41 /sf/in > 4"
Joint Seal Replacement	\$2.24 /lf
Joint Seal Repair	\$0.87 /lf
Undersealing	\$4.16 /sf
Flexible Pavement (AC)	
Reconstruction	\$5.36 /sf
Resurfacing	\$1.44 /sf
Structural Overlay	\$2.25 /sf + \$0.41 /sf/in > 4"
Surface Treatment	\$0.39 /sf
Patching	\$9.78 /lf
Crack Repair (Restorative)	\$1.24 /lf
Crack Repair (Sustaining)	\$0.85 /lf

### 3.2.1 Rigid Pavement Work Descriptions

The following descriptions provide additional information about the typical work items covered by the unit costs shown in Table 3-1.

#### 3.2.1.1 Reconstruction

Reconstruction is recommended when the pavement defects would not be corrected by less extensive measures. Unit prices assume removal of the existing pavement to the subgrade and reconstruction with 8 inches of high strength PCC pavement on 6 inches of aggregate subbase.



#### 3.2.1.2 Repair and Overlay

This procedure usually consists of a rubblize or a crack and seat process, where the existing pavement is broken into segments of approximately 2 ft on a side by dropping a heavy breaker bar onto the pavement. Properly done, aggregate interlock between pavement segments is retained and reflective cracking is reduced. A flexible surface is then placed over the recycled PCC base.





### 3.2.1.3 Slab Replacement

Slab replacements are typically required for high-severity blow ups, scaling, and shattered slabs. Unit prices assume removal of the selected slab to the subgrade. Prepare subgrade to bearing strength equivalent to surrounding subgrade. Provide subbase support equivalent to existing and install load transfer steel as required. Place PCC pavement level with existing surface.



### 3.2.1.4 Patching (Partial Depth)

While partial depth patching is most commonly used to repair joint and corner spalls, it is effective for a wide variety of distress types. Saw cut and remove area of pavement to sound concrete above reinforcing steel. Treat existing concrete to ensure firm bond. Place PCC level with existing surface.



### 3.2.1.5 Joint Seal Replacement

Rout joints and cracks to a depth of at least 1-1/4 inches, clean joint wall surfaces to expose fresh vital concrete, install backing rope, and apply rubberized sealant meeting ASTM D3405 specification, or equivalent.



### 3.2.1.6 Joint Seal Repair

Press existing sealant into joint for use as backer material; apply joint sealant meeting ASTM D3405 specification, or equivalent.

### 3.2.1.7 Undersealing

Undersealing is used to repair faulting between slabs or when corner breaks have settled relative to the slab. High-pressure injection is used to force material into the underlying voids and continues until the settled pavement is restored to its original elevation. Several materials have been used for undersealing, including cement grout, asphalt slurries, and proprietary formulations of expansive Styrofoam.



### 3.2.2 Flexible Pavement Work Descriptions

#### 3.2.2.1 Reconstruction

Reconstruction is recommended when the pavement defects would not be corrected by less extensive measures. Unit prices assume removal of existing pavement to subgrade. Scarify and compact subgrade to 6-inch depth. Construct 4 inches of P401 AC surface course on 8 inches of aggregate base course.



#### 3.2.2.2 Resurfacing

Resurfacing assumes a nominal 2-inch asphalt mill and inlay on existing prepared pavement.



#### 3.2.2.3 Structural Overlay

Structural overlays are used to address load related distress or to increase pavement load bearing capacity. Apply a 4-inch AC overlay on existing prepared pavement. Add additional thickness as needed to achieve required strength.

#### 3.2.2.4 Surface Treatment

Apply a high-quality, penetrating rejuvenating sealer



#### 3.2.2.5 Patching

High-performance cold patching products can be used for short term repairs. Long-term patches should be made with plant mixed hot asphalt meeting FAA P401 specs.

#### 3.2.2.6 Crack Repair (Restorative)

Rout existing crack to a minimum depth of 1-1/4 inches, install backing rope and apply rubberized crack filler meeting ASTM D3405 specification.

#### 3.2.2.7 Crack Repair (Sustaining)

This is typically spot repairs of existing crack sealant.



### 3.3 Capital Improvement Strategies

Figure 3-1 shows a projection of the overall airport pavement condition for the next 10 years based on implementing one of three capital improvement strategies:

- No Action: No capital improvement action is undertaken
- Longest Life: The most comprehensive repair and longest life rehabilitation option
- Lowest Cost: The rehabilitation option with the projected lowest annual cost

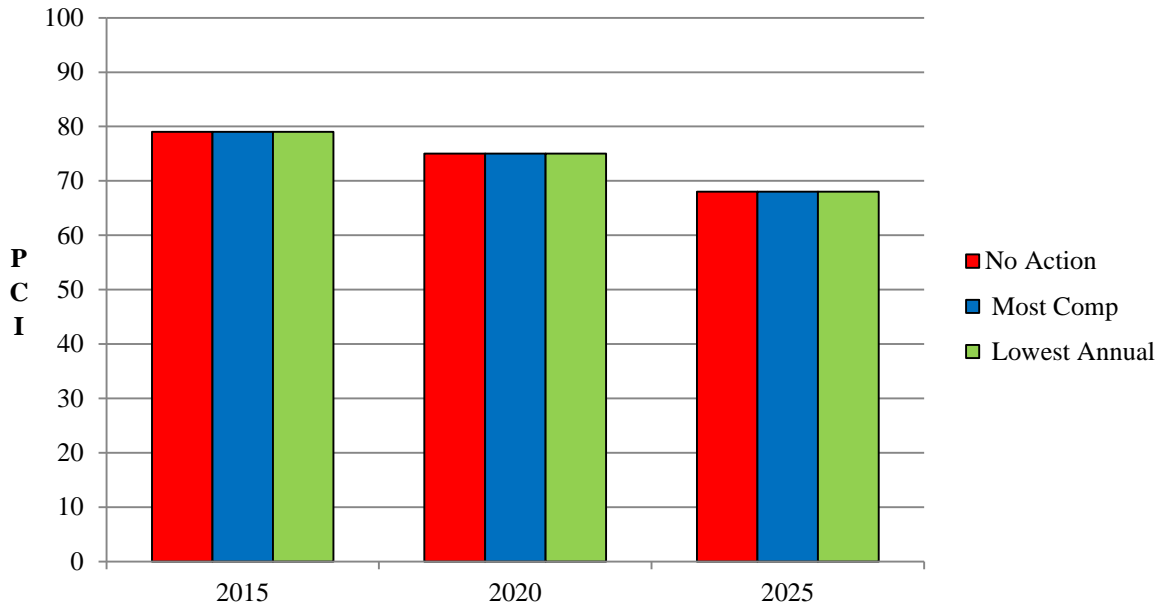

Figure 3-1. Programmed CIP

The longest life CIP scenario for all of the pavement projected to fall below the MSL is projected to cost approximately **\$15,000** over the next 10 years. The corresponding lowest annual cost scenario is also projected to cost approximately **\$5,000** over the next 10 years. Examples of each capital improvement strategy and a complete listing of all viable capital projects are presented in Table 3-2 through Table 3-4.

Table 3-2. Most Comprehensive Repair

Feature	Built	Description	Action Yr	Work Item	Cost, \$
505	2011	TAXILANE	2018	Reconstruction	15,340
<b>Total</b>					<b>15,340</b>

Table 3-3. Lowest Annual Cost Repair

Feature	Built	Description	Action Yr	Work Item	Cost, \$
505	2011	TAXILANE	2018	Structural Overlay	5,294
<b>Total</b>					<b>5,294</b>

Table 3-4. All Viable Options

Feature	Built	Description	Action Yr	Work Item	Cost, \$
505	2011	TAXILANE	2018	Reconstruction	15,340
505	2011	TAXILANE	2018	Structural Overlay	5,294

## 4. Maintenance Management Program

---

### 4.1 General Comments

Most pavement distress types are classified by severity (low, medium, or high). As a general rule, high-severity distresses should be patched, and medium-severity distress should be sealed. A detailed matrix of recommended maintenance policies to address various distress types is provided near the end of this section.

#### 4.1.1 Inspected Crack Severity

Of the inspected pavement, 93 percent of the cracks were rated at low severity and require no maintenance beyond ongoing inspection and spot repair. About 7 percent of the cracks were rated at medium severity and would benefit from sealing and repair. None of the cracks were rated at high severity.

#### 4.1.2 Other Distress

In the asphalt pavement, area measured distresses such as rutting, depressions, alligator cracks, and raveling were recorded as follows: 94 percent at low severity, 5 percent at medium severity, and 2 percent at high severity.

### 4.2 Recommended Maintenance Actions

The following illustrations and tables show pavement areas that have maintenance and repair needs. Ongoing development of capital improvement projects may address some of these maintenance needs. To help budgeting and prevent duplication of effort, all pavement features recommended for maintenance should be compared to planned improvements prior to finalizing a maintenance program strategy.

Table 4-1. Recommend Maintenance Actions

Work Item	Quantity	Unit	Cost
AC RESTORATIVE CRACK REPAIR	3,521	LF	\$4,366
AC SUSTAINING CRACK REPAIR	1,180	LF	\$1,022
<b>Total:</b>			<b>\$5,388</b>

#### 4.2.1 Crack Seal

Table 4-2. Recommend AC Restorative Crack Repair

Feature	Work Item	Amount	Insp. PCI	Change	Est. PCI
110	AC RESTORATIVE CRACK REPAIR	1,144	80	3	83
5001	AC RESTORATIVE CRACK REPAIR	2,377	79	2	81
	TOTAL:	3,521	L.F.		
EQUIPMENT: AIR COMPRESSOR, HEATING KETTLE, HAND TOOLS					
EST. MATERIALS: 704 POUNDS ASTM D3405 SEALANT OR EQUIVALENT					
EST. MATERIAL COST: \$704					
EST. CREW HOURS: 17.6					
EST. CREW COST: \$3,661					
EST. PROJECT COST: \$4,366					

Table 4-3. Recommend AC Sustaining Crack Repair

Feature	Work Item	Amount	Insp. PCI	Change	Est. PCI
101	AC SUSTAINING CRACK REPAIR	208	77	N/A	77
3015	AC SUSTAINING CRACK REPAIR	608	72	N/A	72
5010	AC SUSTAINING CRACK REPAIR	364	80	N/A	80
	TOTAL:	1180	L.F.		
EQUIPMENT: AIR COMPRESSOR, HEATING KETTLE, HAND TOOLS					
EST. MATERIALS: 236 POUNDS ASTM D3405 SEALANT OR EQUIVALENT					
EST. MATERIAL COST: \$236					
EST. CREW HOURS: 5.1					
EST. CREW COST: \$786					
EST. PROJECT COST: \$1,022					

# Sullivan County Airport

## 2015 PCI Inspection

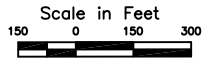

### Recommended Maintenance

Patching



Crack Sealing



Both

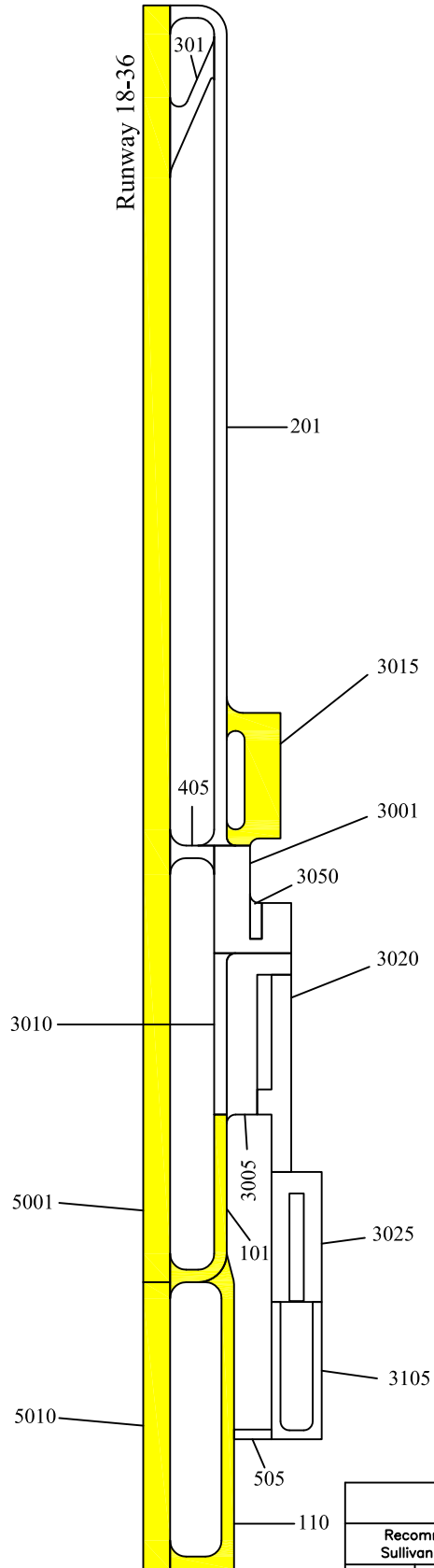

			
Recommended Maintenance Sullivan County Airport (SIV)			
ENGINEER: BDA	DRAWN BY: JCB	DATE: Jan 2016	CTAF 122.8

Figure 4-1. Recommended Maintenance at Sullivan County Airport (SIV).

## 4.3 Pavement Deterioration

Before implementing maintenance and repairs, it helps to understand pavement performance and pavement deterioration. The factors that contribute most to deterioration are environmental, materials, and/or load related. Brief discussions of each are presented in the following sections.

### 4.3.1 Environmental/Age-Related Deterioration

Seasonal and daily temperature changes cause expansion and contraction of the pavement materials. The shear stresses created by expansion and contraction can cause transverse cracking in flexible pavement and mid-slab cracking in rigid pavement. Further, expansion and contraction will cause cracks, and rigid pavement joints, to open and close with changes in temperature.

Flexible pavement oxidizes as it ages, losing its lighter, volatile, components and becoming brittle with time. Surface treatments and seal coats are designed, in part, to provide a protective barrier and slow this type of oxidation.

Subsurface water can have the greatest impact on pavement deterioration. A wet subgrade greatly reduces the ability of a pavement to support wheel loads, and the results often show up as rutting and cracking of flexible pavement. The fine materials in a wet base can be pumped up through the cracks and eventually result in a loss of support. This loss of support can be evidenced as corner breaks and faulting in rigid pavement. Moisture inside a pavement system expands when it freezes, creating stresses that cause the pavement surface to heave. Subsequent freeze-thaw cycles leave voids in the pavement structure that enable further rutting and breaking. Repeated freeze-thaw cycles eventually cause the pavement to disintegrate. Freeze-thaw deterioration requires frost-susceptible material, sub-zero temperatures, and water. If one of these factors is removed, freeze-thaw damage will not occur. One of the best ways to ensure pavement longevity is to provide drainage and keep it dry.

### 4.3.2 Materials-Related Deterioration

The pavement thickness and type of subgrade play a large role in the formation and spacing of transverse cracks. If the subgrade and base materials are smooth or rounded and allow for relatively free movement of the pavement surface, transverse cracks will often be spaced far apart (>60 feet). If the subgrade and base material are rough or angular and provide greater resistance to movement of the pavement surface, transverse cracks will be spaced more closely (<40 feet). The distance between transverse cracks also depends on the pavement thickness, as a thicker pavement can resist cracking for longer lengths. At general aviation airport pavements, around 50 feet is typical transverse crack spacing.

Aggregate is the biggest component of any pavement structure. It is the contact between the aggregate particles that actually transfers the load and provides the strength. Aggregate durability and shape are major factors affecting pavement performance. Durability is the ability of the aggregate to perform satisfactorily over time and resist deterioration. Sharp, well-angled aggregates that interlock, compact densely, and resist movement are the most desirable.



In flexible pavement, the selection of asphalt cement can have a significant impact on pavement performance. Asphalt is visco-elastic, which means it is stiff at low temperatures and flows at high temperatures. With this in mind, asphalt pavement should be designed to remain stiff on hot summer days to resist plastic deformation (rutting and shoving). In addition asphalt pavement should have sufficient cold temperature flexibility on cold winter days to resist transverse cracking. The proper selection of asphalt cement grade and maintaining adequate mix volumetrics (air voids, voids in the mineral aggregate, etc.) are key factors in the performance of flexible pavement.

As water freezes, it expands and occupies a greater volume than in its liquid state. In PCC pavement, interconnected, well-distributed air voids are required to allow for expansion of moisture within the PCC. PCC mixes with insufficient air entrainment are susceptible to freeze-thaw damage, as the expansive forces have been shown to cause concrete deterioration. Small, closely spaced, interconnected air voids provide the greatest degree of protection.

Asphalt paving mixes also require air voids, but for reasons different than for PCC pavement. When a well-constructed asphalt pavement is subjected to vehicle loading, it will nevertheless experience some minor secondary consolidation. Air voids allow for the safe movement of the asphalt binder within the mix. With insufficient air voids, the asphalt binder will migrate to the surface of the pavement—it will in essence, get squeezed out of the mix. This phenomenon is called flushing. In addition, these mixes become unstable and are prone to rutting in the wheel paths.

However, if the air voids become too high, air and water can penetrate the pavement, reducing both durability and flexibility. Air infiltration will accelerate oxidization of the binder, while water penetration will increase the moisture susceptibility of the mix (i.e., stripping of the asphalt cement from the aggregate). Air voids in flexible pavement should be kept low enough to prevent water and air from penetrating the asphalt layers, but high enough to minimize the potential of plastic deformation.

Regardless of whether the pavement binder is AC or PCC, binder materials are mixed with aggregate to coat all aggregate particles with a thin binder film. Durability of flexible asphalt pavement is increased with a thicker binder film, and the pavement becomes more resistant to age hardening; however, if the film is too thick, the asphalt acts like a lubricant, promoting ruts, shoving, and bleeding. Each asphalt mix should be customized for materials available locally.

With a concrete pavement, aggregate interlock supports the wheel loads, and the hydrated cement binder further interlocks the aggregate particles to inhibit all movement. “Hydration” is the term for the chemical reaction of portland cement with water. In the hydration process, dry cement particles react with water to form gels, and then crystals, that grow and bond with the aggregate and form a rigid interlocking structure. Hydration can continue for years, but much of the ultimate strength will be reached within 28 days. Hydration is a sensitive chemical process. Typically, any admixtures used to accelerate the hydration process will reduce durability, and admixture use should be considered carefully or avoided.

### 4.3.3 Load-Related Deterioration

As illustrated below, rigid and flexible pavements differ in the way loads are distributed. A concrete slab resists bending and transfers loads evenly, while an asphalt pavement is designed to bend, gradually spreading loads over wider areas.

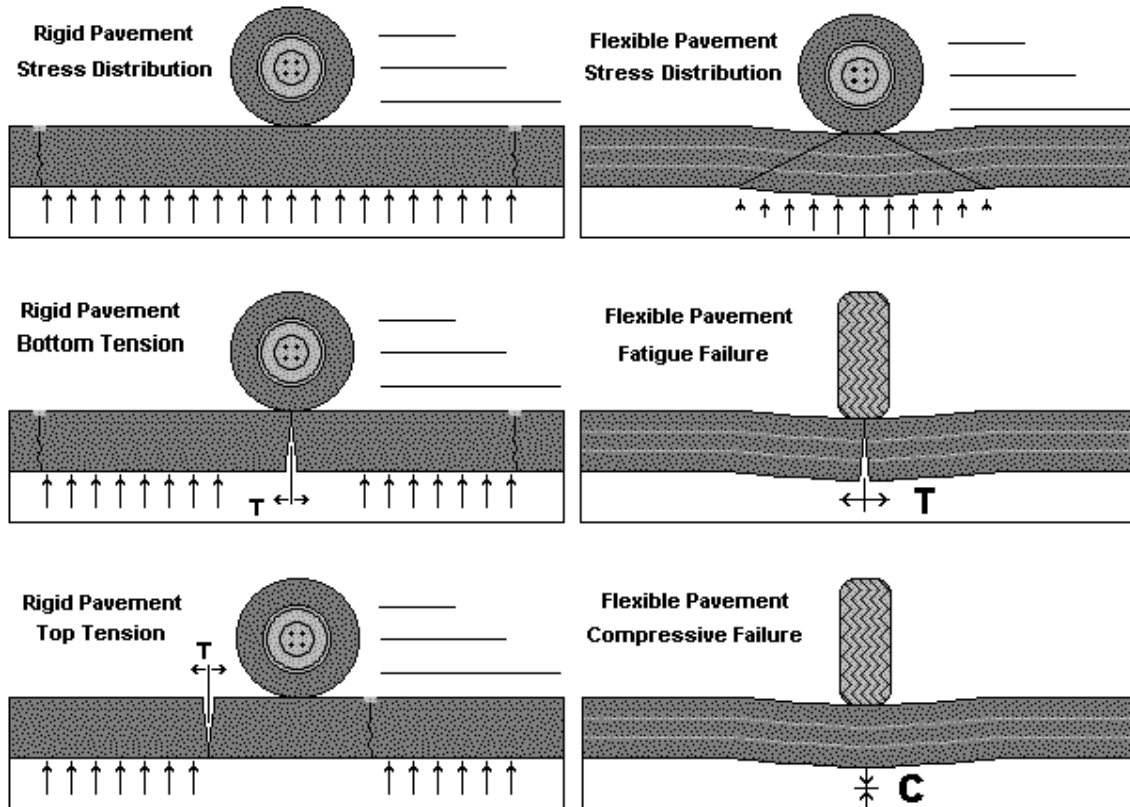

Load-related cracks can start at the top or bottom of a pavement section. In asphalt sections, load-related (fatigue) cracks start at the bottom. If a load-related crack reaches the surface, it usually indicates structural deficiency. In rigid pavement, corner breaks are caused by tensile forces at the top of the slab, and the crack propagates downward. Mid-slab LTD cracks are distress examples resulting from tensile forces at the bottom of the slab.

Both wheel loads and environmental factors can cause spalls anytime there is movement between adjacent slabs. If non-compressible material (such as a small rock) is allowed into a joint, stresses will build up between adjacent slabs and can cause a spall. Keeping joint and crack sealant intact can help to reduce the infiltration of non-compressible material and minimize spalling.

## 4.4 Best Practices

### 4.4.1 Flexible Pavement

L&T cracks at medium severity should be filled with a good quality crack sealant material. High-severity cracks normally must be patched.

Cracks rated at low severity may be narrow unsealed cracks or sealed cracks up to 3 inches wide. The PCI procedure does not distinguish between narrow unfilled cracks and wider filled cracks. Some L&T cracks at low severity are included in the estimated sealing quantities and costs in this maintenance plan. In general, when medium- or high-severity cracking constitutes less than 25 percent of the total crack quantity, sustaining maintenance usually is more cost-effective. When 25 percent or more of the total crack quantity is at medium or high severity, a restorative program typically becomes more cost-effective.

Existing patches rated as medium and high severity should be replaced with new patches. Small areas (usually less than 100 square feet per patch) of alligator cracking and rutting at medium and high severity also may be repaired cost-effectively by patching. Larger patches should be considered if equipment can be made available to accomplish the work. Patching to repair up to 10 percent of the surface of a pavement feature that is otherwise serviceable can result in significant cost savings as compared to rehabilitation of the entire feature.

An example maintenance policy treatment matrix for flexible pavement is shown in Table 4-4. Examples of various maintenance techniques are provided in appendix B.

### 4.4.2 Rigid Pavement

Joint seal damage rated at medium and high severity should be repaired. If medium- and high-severity damage is limited to less than about 25 percent of the total joint length, sustaining maintenance is recommended. If medium- and high-severity damage exceeds 25 percent of the total joint length, the joint sealant should be removed and replaced under a restorative repair project.

LTD cracks at low and medium severity should be considered for sealing as part of the joint sealing project. High-severity LTD cracks require sealing, patching, or slab replacement, depending on the extent of deterioration.

Small patches are typically used to repair medium- and high-severity spalls or to replace deteriorated older patches. Restorative small patches are typically partial-depth repairs, usually to a maximum depth of 1/3 the slab thickness. Large patches and corner breaks at medium and high severity should be repaired by full-depth large patches.

High-severity LTD cracks and shattered slabs are candidates for patching and slab replacement. Low-severity shattered slabs can be left in place pending further deterioration.

An example maintenance policy treatment matrix for rigid pavement is shown in Table 4-4. Examples of various maintenance techniques are provided in appendix B.

Table 4-4. General Maintenance Policy (AC)

Distress Type	Distress Severity	Maintenance Action
Alligator Cracking	Low	Crack Sealing - AC
	Medium	Patching - AC Deep
	High	Patching - AC Deep
Bleeding	N/A	Monitor
Depression	Low	Monitor
	Medium	Patching - AC Shallow
	High	Patching - AC Deep
Jet Blast	N/A	Patching - AC Shallow
Longitudinal, Transverse, Joint Reflective, & Block Cracking	Low	Monitor
	Medium	Crack Sealing - AC
	High	Patching - AC Deep
Oil Spill	N/A	Patching - AC Shallow
Patching	Low	Monitor
	Medium	Crack Sealing - AC
	High	Patching - AC Deep
Polished Aggregate	N/A	Monitor
Weathering / Raveling	Low	Monitor
	Medium	Surface Treatment
	High	Patching - AC Shallow
Rutting, Corrugation and Swell	Low	Monitor
	Medium	Patching - AC Deep
	High	Patching - AC Deep
Shoving	Low	Monitor
	Medium	Patching - AC Shallow
	High	Patching - AC Deep
Slippage Cracking	N/A	Patching - AC Shallow

Table 4-5. General Maintenance Policy (PCC)

Distress Type	Distress Severity	Maintenance Action
Blow Up	Low	Patching - PCC Partial Depth
	Medium	Slab Replacement - PCC
	High	Slab Replacement - PCC
Longitudinal, Transverse & Diagonal Cracking	Low	Monitor
	Medium	Crack Sealing - PCC
	High	Patching - PCC Full Depth
Durability Cracking	Low	Monitor
	Medium	Patching - PCC Full Depth
	High	Slab Replacement - PCC
Large Patch & Corner Break	Low	Monitor
	Medium	Patching - PCC Full Depth
	High	Patching - PCC Full Depth
Popout / Shrinkage Cracks	N/A	Monitor
Scaling	Low	Monitor
	Medium	Patching - PCC Partial Depth
	High	Slab Replacement - PCC
Faulting	Low	Monitor
	Medium	Grinding (Localized)
	High	Grinding (Localized)
Shattered Slab	Low	Monitor
	Medium	Crack Sealing - PCC
	High	Slab Replacement - PCC
Joint Spall, Corner Spall & Small Patch	Low	Monitor
	Medium	Patching - PCC Partial Depth
	High	Patching - PCC Partial Depth
Alkali Silica Reaction	Low	Monitor
	Medium	Slab Replacement - PCC
	High	Slab Replacement - PCC

## **4.5 Pavement Repair Materials**

New pavement repair materials are introduced and improved regularly. This section provides information on products compatible with airport needs.

### **4.5.1 Joint and Crack Sealer**

Hot-poured, pressure-injected, polymeric rubberized asphalt sealant meeting ASTM D3405 specifications is suitable for most sealing requirements. This product is relatively inexpensive, durable, and suitable for both rigid and flexible pavements. Other, more expensive, hot-applied sealants that promise longer life are being developed for specialty applications. Twin component cold applied sealants also have been used with success. Contact your local distributor.

### **4.5.2 Flexible Pavement Patch**

High-performance plant mixed cold patching products that can be stockpiled on-site can be used for short term repairs to maintain safety. Long-term patches should be made with high-quality plant mixed hot asphalt having a ¾-inch maximum aggregate size and meeting Federal Aviation Administration (FAA) P401, or highest quality highway specifications. Low-quality packaged materials available from local hardware type stores should be avoided.

### **4.5.3 Rigid Pavement Patch**

Permanent patches in rigid pavement should be made with air-entrained concrete with 1-inch maximum size aggregate. If the area must be quickly opened to traffic, high early concrete should be considered. Concrete should have zero slump and a coarse texture. As with asphalt patches, low-quality packaged materials should be used only as temporary patches to maintain safety and service until a more permanent repair can be made.

## **4.6 Pavement Repair Equipment**

Many pavement repair and sealing products are available. Specialized tools and equipment help ensure high-quality repairs. This section discusses equipment compatible with airport needs.

### **4.6.1 Air Compressor**

Used to remove non-compressible sand and debris from prepared cracks and joints, the compressor should have a sustained capacity of 120 cubic feet per minute with a nozzle velocity of 100 psi. Trailer-mounted compressors typically have capacities in this range.

### **4.6.2 Concrete Saw**

A saw capable of making a minimum 3-inch-deep cut is required. The saw should be capable of making cuts in both asphalt and concrete. Gasoline-powered 5- to 25-hp wheel-mounted saws typically are preferred for this type of work, but electric and pneumatic tools also are available.

#### **4.6.3 Heating Kettle**

Applying sealant is the most time-consuming operation, and a sealing machine with heating and pressure application capabilities is a critical item in a successful sealing program. The capacity of the sealing equipment dictates the rate at which a crew progresses. For large sealing projects, a minimum 100-gallons/hour sustained capacity is recommended. The unit should be a double boiler type, with mechanical agitators or continuous recirculation. Kettle temperature must be monitored to ensure that the sealant is not “burned.” Overheating the sealant will prematurely age harden the material.

#### **4.6.4 Router**

A concrete saw can be used to prepare joints, but for random cracking, a mechanical router with a vertical impact mechanism is preferred. When cracks are being routed, this activity will dictate the speed of the crew. Crack routers in the 25-hp range are commonly used and are available from a variety of manufacturers.

#### **4.6.5 Sand Cleaner**

A sand blaster helps to clean loose particles and dust from prepared cracks. The unit must have sufficient force to expose fresh, vital pavement to bond with sealant and patching materials.

#### **4.6.6 Vibratory Roller or Plate Compactor**

Required to compact plant mixed and packaged patching materials properly. Small rollers are best for pothole type applications; plate compactors are best for large areas.

#### **4.6.7 Other Equipment**

Other general use equipment that can be helpful in a maintenance program includes bucket loaders, dump trucks, water tanks, and a power sweeper unit.

This page intentionally left blank



## Appendix A. AIRPAV Software

---

### The Software

Data analysis was performed using the AIRPAV pavement evaluation and management software. In addition to calculating and documenting PCI values, AIRPAV evaluates the collected inspection data and recommends rehabilitation actions that address the cause of pavement distress. AIRPAV can incorporate traffic and structural capacity evaluations into the pavement evaluation matrix, and AIRPAV also performs preliminary life cycle cost analysis of the various rehabilitation alternatives, providing guidance on the lowest annual cost repair strategy.



A complete database, along with an updated version of AIRPAV, is provided on INDOT computers for ongoing management of the INDOT pavement systems.

### *Capital Improvements*

AIRPAV creates interactive CIPs, providing the user with the ability to input unit costs, develop new projects, move projects between years, and even increase or decrease the scope and cost of individual projects.

## Maintenance

AIRPAV calculates and develops maintenance work orders organized by type of work. Maintenance work orders can be printed and issued directly to maintenance crews.

## Traffic

AIRPAV provides the ability to model aircraft ground movements. Traffic can be sorted by airline, aircraft type, destination gate or ramp, and runway used. The program graphically displays each taxi path, accumulates total operations, automatically determines design aircraft, and calculates structural overlay requirements for each pavement feature. The software can provide Pavement Classification Numbers (PCN) for each pavement feature or report results directly as inches of overlay required.

## Maps

AIRPAV permits viewing and printing of PCI maps. Inspection layout, pavement condition, and other views are available from within the software.

## Query

The AIRPAV query function is a powerful search tool that allows users to extract useful reports meeting various criteria. For example, lists can be created for taxiway pavement, asphalt pavement, or areas below MSL at the time of inspection.

## Global Information System (GIS) Integration

AIRPAV is fully GIS-enabled. A single click in AIRPAV exports all data to an MS Access database that can be linked to shape files used in an ESRI product. In this way, virtually all data in the pavement management database can be accessed in GIS format.

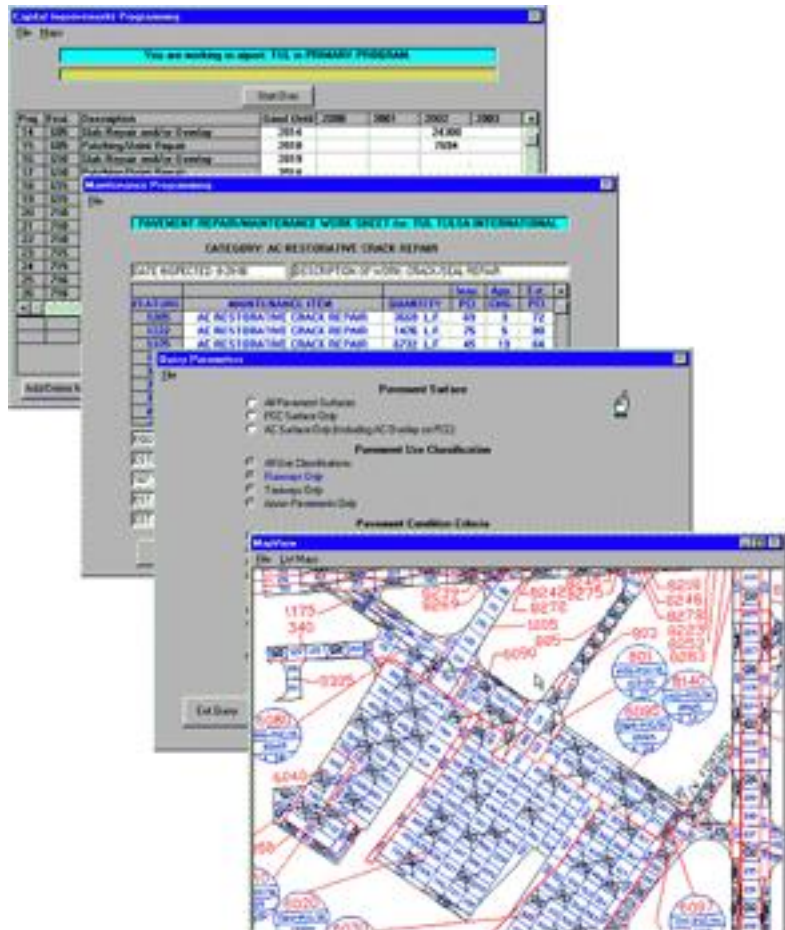

## Appendix B. General Maintenance Techniques

### Crack Sealing

- Cracks over ¼ inches wide should be sealed.
- Cracks wider than 3 inches should be patched.
- Sealant depth above the backer rope should be equal to the width of the reservoir, or as recommended by the manufacturer.
- Routed cracks should be sand blasted, to prepare for bonding with the sealant.
- Clean cracks with compressed air prior to sealing.
- Backing material should always be placed into the cracks. Commercial products are available. Several sizes of rope should be available to accommodate various crack sizes.
- Apply sealant after placing the backer rope. Follow the manufacturer's instructions. Sealant should be applied to within ¼ inch of the pavement surface.
- The final activity is to clean the surrounding pavement areas. A vacuum sweeper works well for this. Allow the sealant time to set before using a broom.
- Consider hot-applied, pourable patch material for cracks > ½ inch and any subsidence or depressions.

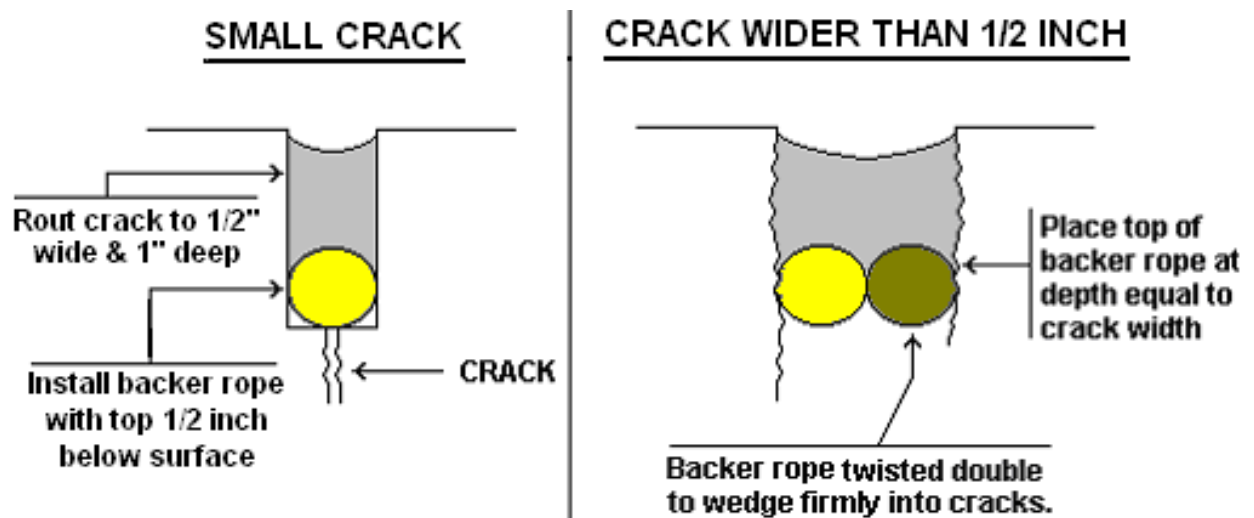

## Overband Technique

An alternate crack sealing technique using the procedures outlined below.

### Material

- Blend grade 20 or equivalent asphalt cement and latex rubber at 5 percent by weight asphalt.
- Again, at 5 percent by weight of asphalt, add polyester fibers into agitator tank.
- Maintain blended asphalt temperature at least 20 degrees below flash point.
- Continuously recycle hot blended asphalt through pumps and hoses when heating kettle is in standby mode.

### Application

- Sealant should be applied to dry pavement, with ambient temperatures above 40 degrees.
- Cracks should be sand cleaned and blown free of debris immediately before sealing.
- Application of sealant immediately follows cleaning of the crack.
- Sealant should be pressure applied from a wand-type applicator with “overband” nozzle.
- Seat the sealant with a steel-wheeled roller immediately after placement.
- In wider cracks, a backer rope is recommended to limit material quantities required.

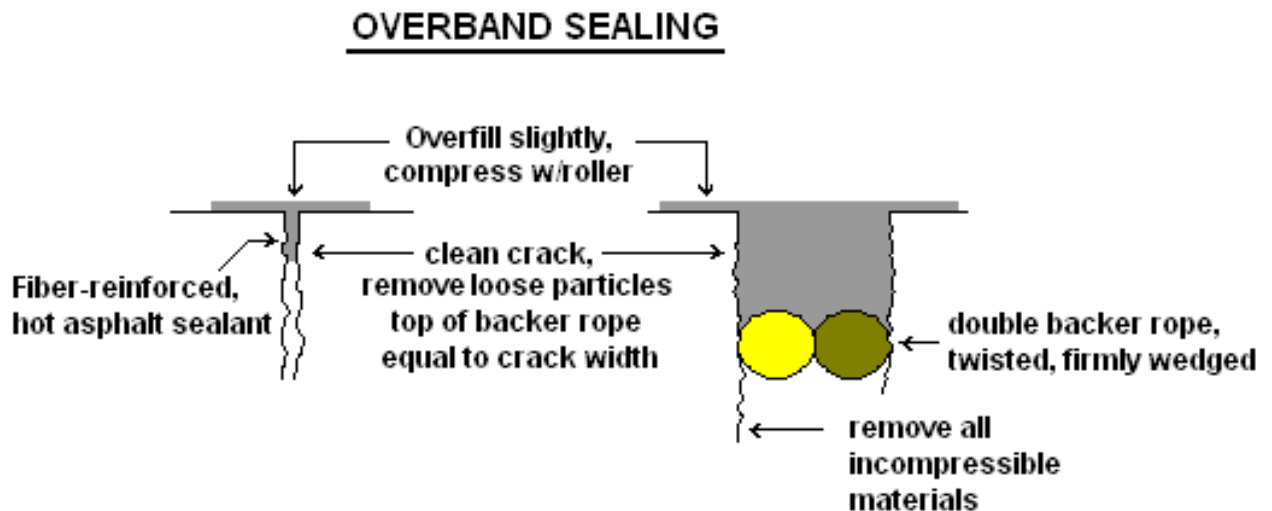

### Joint Repair (portland cement)

- Rout a reservoir for the sealant ½ inch wide and 1 inch deep.
- Cracks wider than ½ inch should have reservoirs ¼ inch wider than the crack. Reservoir height above backer rope should be less than reservoir width, or as recommended by manufacturer.
- Routed cracks should be cleaned to expose fresh, vital pavement on the vertical crack edge.
- Cracks should be cleaned to remove all sand, debris, and other materials from the crack.
- Backing material should be placed into the crack.
- Apply sealant to within ¼ inch of pavement surface, following manufacturer's instructions.
- Clean the surrounding pavement area.

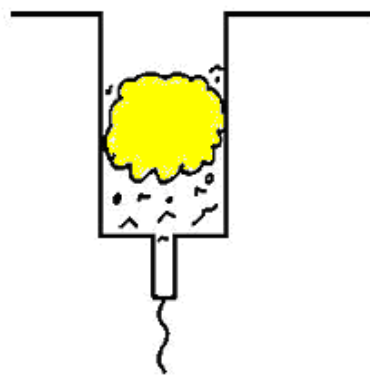

Typical failed joint sealant, w/ debris and incompressibles.

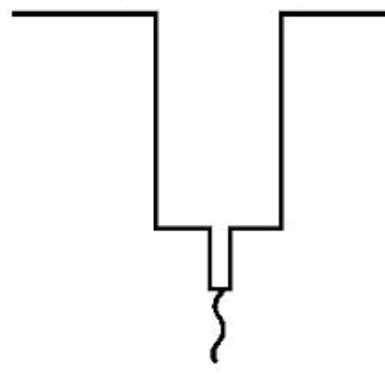

Clean joints exposing fresh, clean concrete and stone. Retain existing reservoir shape.

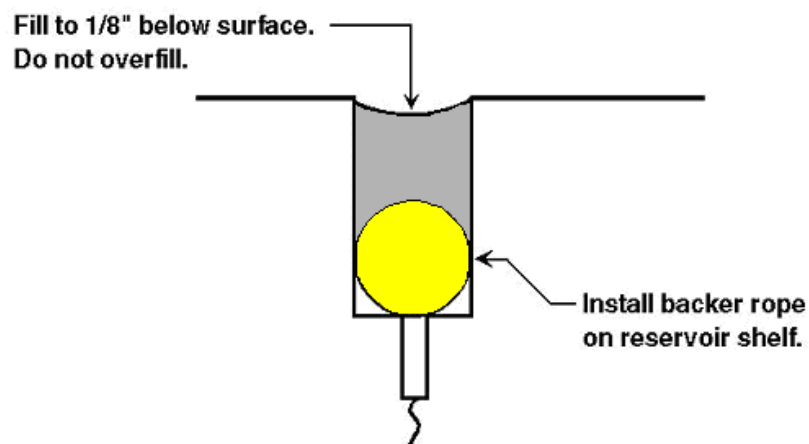

## Patching (bituminous material)

- Examine distressed area and mark patch outline.
- Cut patch area with saw, no less than 3 inches deep.
- Remove enclosed pavement, leaving the vertical sawed edges undamaged.
- Clean sides and bottom and blow out with compressed air
- Paint sides and bottom with rapid curing asphalt tack coat. Prevent pooling on bottom.
- Allow tack coat to cure until it reaches a gummy consistency.
- Place hot mixed asphalt concrete and mound slightly, allowing for compaction.
- Compact with vibratory roller or plate compactor, in layers no greater than 6 inches.

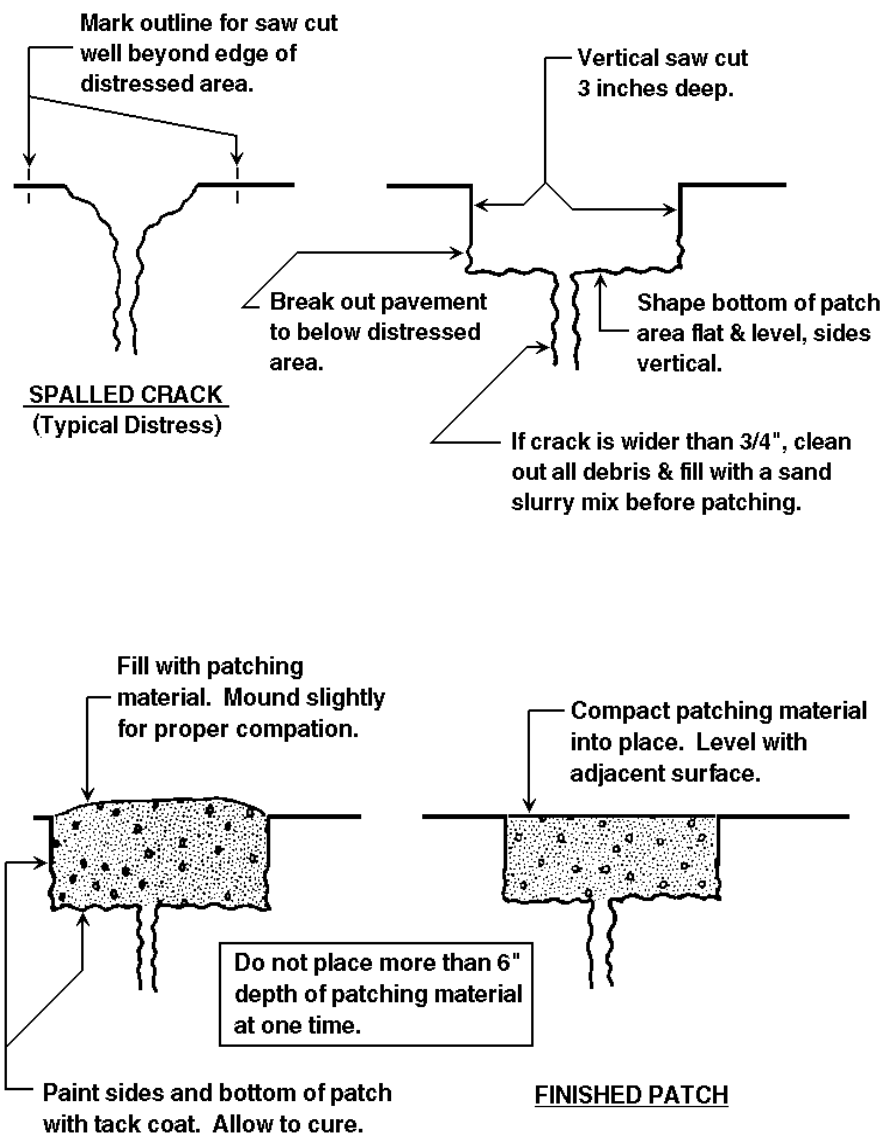

## Patching (pourable materials)

Hot-applied, pourable materials generally are used to repair deficiencies larger than can be repaired by sealants, but smaller than those where traditional techniques would be required. Suggested uses for this type of repair include cracks over 2 inches wide, potholes less than 4 inches deep, as a leveling for small depressions, as a cap for settled utility cuts, and as a skin patch for areas of alligator cracking.

- Examine and mark the patch outline. Boundaries should extend to sound pavement.
- Apply patch material to clean, dry surfaces.
- A heating lance to preheat or dry existing pavement is recommended in cold or wet conditions.
- Patch material should be poured into the area to be repaired and leveled as appropriate.
- Patch edges should be sealed after application to assure good adhesion, preventing surface moisture from migrating under patch edges.

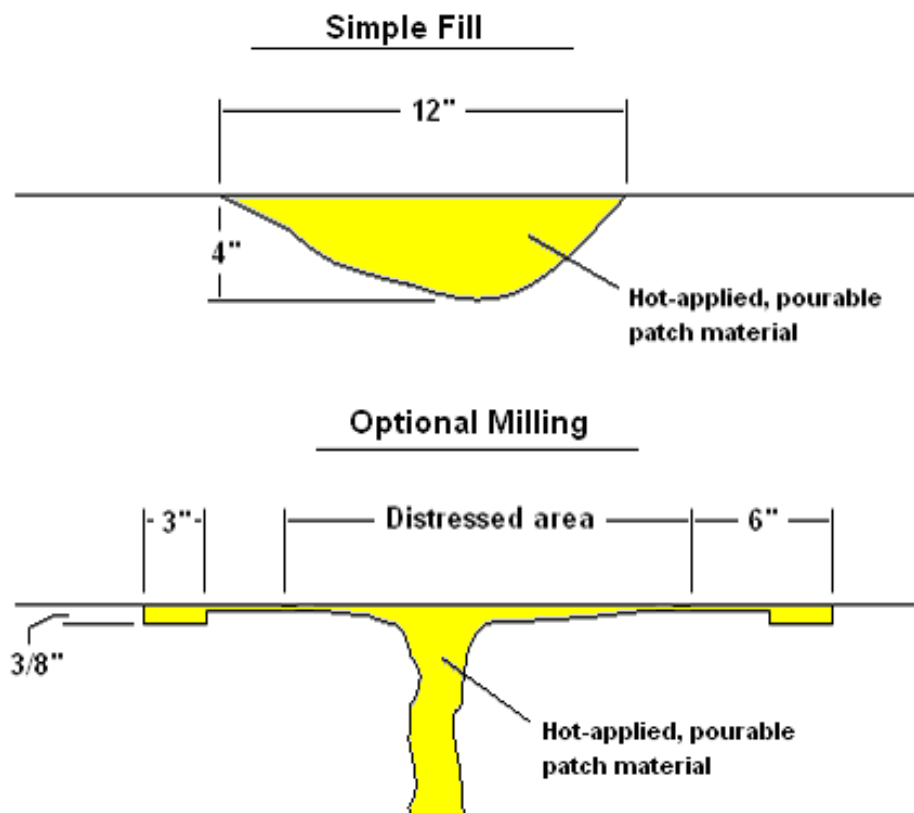

## Patching (PCC)

The technique outlined here simulates a thin bonded PCC overlay. This procedure has been proven effective in service throughout the country.

- Examine and mark patch outline.
- Saw cut area to a depth of 2 inches. The enclosed area is then chipped or jack hammered to solid pavement, but not less than a 2-inch nominal depth.
- The sides and bottom are sand cleaned and air-blasted to expose vital, clean concrete.
- A 25 percent solution of muriatic acid is applied to all exposed surfaces within the patch.
- The muriatic acid solution is thoroughly flushed from the patch area with water.
- Compressed air is used to remove excess water from the area, but exposed concrete must be maintained in a moist condition.
- The sides and bottom of the area are then coated with approximately a 1/16-inch layer of cement grout applied at the consistency of paste. The grout acts as an adhesive to bond the fresh concrete to existing concrete.
- If the patch is adjacent to joints, the continuity of the joint must be maintained by placing inserts approximately the shape of the desired joint against the wall of the patch.
- Before concrete grout begins to dry, concrete is placed in the patch area and is compacted into position with hand tampers or a vibrating plate tamper.
- When the patch has been struck to the proper slope and elevation, a surface texture is applied to approximate the texture of adjacent pavement.
- Joint edges may be edged slightly to remove sharp edges. The patch should be covered with polyethylene or sprayed with a curing compound.
- Clean the surrounding pavement before concrete spillover has a chance to set up.
- The patch may be open to traffic in 72 hours.



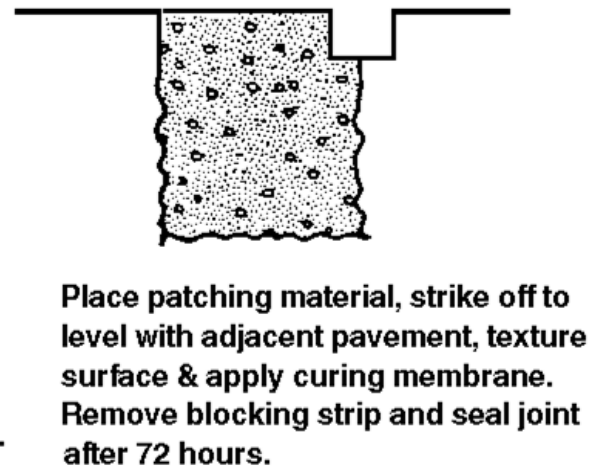
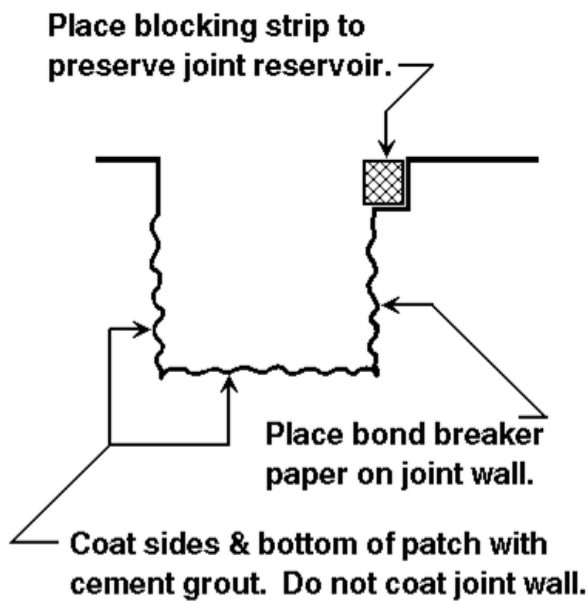
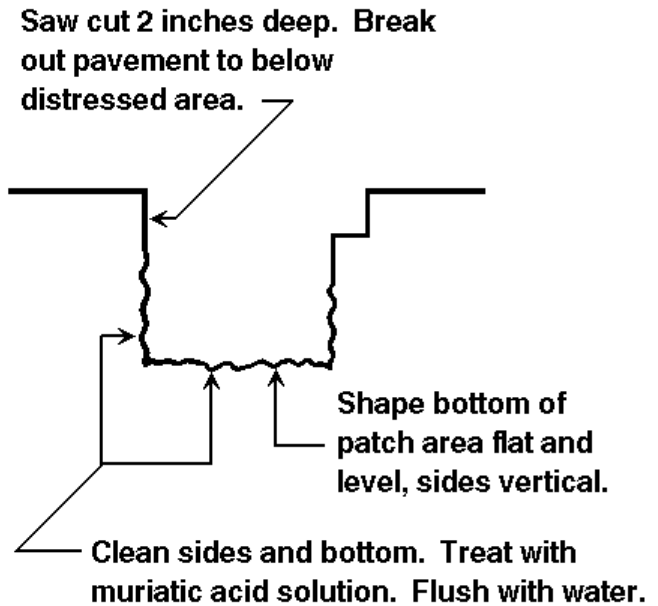
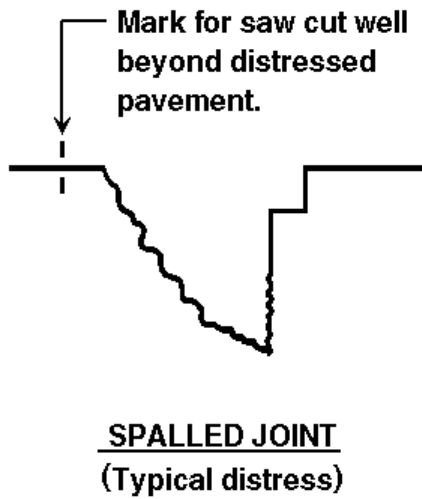

This page intentionally left blank

## Appendix C. PCI Summary

The PCI summary provides an index of pavement conditions at the airport. The letter in the first column indicates the type of pavement, asphalt or portland cement. The last column lists the distress types found in each sample unit. The distress types are listed by a numbering code for each type of pavement, shown at the beginning of the summary.

AIRPAV						
CONDITION SURVEY SUMMARY						
AIRPORT: 417 GREENCASTLE-PUTNAM COUNTY				DATE: 12-30-2009		
"A" FLEXIBLE PAVEMENT DISTRESS CODES				"T" RIGID PAVEMENT DISTRESS CODES		
1. ALLIGATOR CRACKING 2. BLEEDING 3. BLOCK CRACKING 4. CORRUGATION 5. DEPRESSION 6. JET BLAST EROSION 7. JOINT REFL. CRACKING 8. LONG & TRANS. CRACKING 9. OIL SPILL 10. PATCHING 11. POLISHED AGGREGATE 12. RAVELLING/WEATHERING 13. RUTTING 14. SHOIVING FROM PCC SLAB 15. SLIPPAGE CRACKING 16. SWELLING				1. BLOW UP 2. CORNER BREAK 3. LTD CRACKING 4. "D" CRACKING 5. JOINT SEAL DAMAGE 6. SMALL PATCH 7. LARGE PATCH 8. POPOUTS 9. PUMPING 10. SCALING/MAP CRACKING/CRAZING 11. FAULTING 12. SHATTERED SLAB 13. SHRINKAGE CRACKING 14. JOINT SPALLING 15. CORNER SPALLING		
FEATURE:	SAMPLE UNIT:	AREA:	DATE:	SURVEYED BY:	PCI:	DISTRESSES PRESENT:
105 A	105.100	3750	8-16-09	JB	83	8 12
105 A	105.103	3500	8-16-09	JB	79	8 12
105 A	105.105	3500	8-16-09	JB	63	5 8 10 12*
105 A	105.106	3500	8-16-09	AN	79	1 8
105 A	105.109	3500	8-16-09	AN	86	8
105 A	105.112	3500	8-16-09	AN	84	8 12
<b>MEAN FEATURE PCI = 81</b> BASED ON A SAMPLED AREA OF 21250 SQUARE FEET - PCI SPREAD FOR FEATURE = 22.74 DESCRIPTION: TAXIWAY A						
110 A	110.102	3500	8-16-09	JB	100	
110 A	110.106	3500	8-16-09	JB	100	
110 A	110.110	3500	8-16-09	JB	100	
110 A	110.112	3500	8-16-09	JB	100	
110 A	110.114	3500	8-16-09	JB	100	
110 A	110.118	1750	8-16-09	JB	94	8
<b>AVERAGE FEATURE PCI = 99</b> BASED ON A SAMPLED AREA OF 19250 SQUARE FEET - PCI SPREAD FOR FEATURE = 6.20 DESCRIPTION: TAXIWAY A						
115 A	115.118	1750	8-16-09	JB	94	8
115 A	115.122	3500	8-16-09	JB	95	8
115 A	115.126	3500	8-16-09	JB	96	8
115 A	115.130	3500	8-16-09	JB	96	8
115 A	115.134	3500	8-16-09	JB	96	8
115 A	115.136	3500	8-16-09	JB	94	8
115 A	115.138	3500	8-16-09	JB	96	8
115 A	115.142	3500	8-16-09	AN	93	8
<b>AVERAGE FEATURE PCI = 95</b> BASED ON A SAMPLED AREA OF 26250 SQUARE FEET - PCI SPREAD FOR FEATURE = 3.38 DESCRIPTION: TAXIWAY A						
210 A	210.200	3500	8-16-09	AN	94	8
210 A	210.201	3500	8-16-09	AN	94	8
210 A	210.202	1190	8-16-09	AN	86	8
<b>AVERAGE FEATURE PCI = 91</b> BASED ON A SAMPLED AREA OF 8190 SQUARE FEET - PCI SPREAD FOR FEATURE = 7.93 DESCRIPTION: CONNECTOR TAXIWAY B						

Sample units marked with an asterisk (\*) are additional sample units. Additional sample units do not represent the typical condition of surrounding sample units in the pavement features.

The PCI summary provides a quick overview of the pavement condition and consistency. Are the distress types similar? Do the individual sample units have consistent PCI ratings? Answering these questions is a start to understanding your dynamic pavement system.

## CONDITION SURVEY SUMMARY

AIRPORT: SIV SULLIVAN COUNTY

DATE: 01-06-2016

## "A" FLEXIBLE PAVEMENT DISTRESS CODES

1. ALLIGATOR CRACKING
2. BLEEDING
3. BLOCK CRACKING
4. CORRUGATION
5. DEPRESSION
6. JET BLAST EROSION
7. JOINT REFL. CRACKING
8. LONG. & TRANS. CRACKING
9. OIL SPILL
10. PATCHING
11. POLISHED AGGREGATE
12. RAVELLING
13. RUTTING
14. SHOVING FROM PCC SLAB
15. SLIPPAGE CRACKING
16. SWELLING
17. WEATHERING

## "P" RIGID PAVEMENT DISTRESS CODES

1. BLOW UP
2. CORNER BREAK
3. LTD CRACKING
4. "D" CRACKING
5. JOINT SEAL DAMAGE
6. SMALL PATCH
7. LARGE PATCH
8. POPOUTS
9. PUMPING
10. SCALING/MAP CRACKING/CRAZING
11. FAULTING
12. SHATTERED SLAB
13. SHRINKAGE CRACKING
14. JOINT SPALLING
15. CORNER SPALLING
16. ALKALI SILICA REACTION

FEATURE:	SAMPLE UNIT:	AREA:	DATE:	SURVEYED BY:	PCI:	DISTRESSES PRESENT:
101 A	101.102	3500	8-20-15	ABN	79	8
101 A	101.103	3500	8-20-15	ABN	77	8 17
101 A	101.104	3500	8-20-15	ABN	76	8 17

AVERAGE FEATURE PCI = 77

BASED ON A SAMPLED AREA OF 10500 SQUARE FEET - PCI SPREAD FOR FEATURE = 3.21

DESCRIPTION: PARALLEL TAXIWAY

110 A	110.101	2700	8-20-15	ABN	70	1 8 17
110 A	110.103	3500	8-20-15	ABN	79	1 8
110 A	110.105	3500	8-20-15	ABN	81	8 17
110 A	110.108	3500	8-20-15	ABN	90	8

AVERAGE FEATURE PCI = 80

BASED ON A SAMPLED AREA OF 13200 SQUARE FEET - PCI SPREAD FOR FEATURE = 20.25

DESCRIPTION: PARALLEL TAXIWAY

201 A	201.101	3500	8-20-15	ABN	72	5 8 17
201 A	201.104	3500	8-20-15	ABN	72	8 17
201 A	201.108	3500	8-20-15	ABN	68	8 17
201 A	201.111	3500	8-20-15	ABN	70	8 17
201 A	201.115	3500	8-20-15	ABN	70	8 17
201 A	201.118	3500	8-20-15	ABN	71	8 17
201 A	201.120	3500	8-20-15	ABN	68	3 8 17

AVERAGE FEATURE PCI = 70

BASED ON A SAMPLED AREA OF 24500 SQUARE FEET - PCI SPREAD FOR FEATURE = 3.51

DESCRIPTION: PARALLEL TAXIWAY

301 A	301.201	4000	8-20-15	ABN	70	8 17
301 A	301.202	4400	8-20-15	MJP	69	8 17

AVERAGE FEATURE PCI = 70

BASED ON A SAMPLED AREA OF 8400 SQUARE FEET - PCI SPREAD FOR FEATURE = 0.51

DESCRIPTION: NORTH LOOP TWY

405 A	405.100	5600	8-20-15	MJP	68	8 17
-------	---------	------	---------	-----	----	------

AVERAGE FEATURE PCI = 68

BASED ON A SAMPLED AREA OF 5600 SQUARE FEET - PCI SPREAD FOR FEATURE = 0.00

DESCRIPTION: RAMP CONNECTOR

**FEATURE:            SAMPLE UNIT:            AREA:            DATE:            SURVEYED BY:            PCI:            DISTRESSES PRESENT:**

505 A            505.100            2862            8-20-15            ABN            69            5 8

**AVERAGE FEATURE PCI = 69  
 BASED ON A SAMPLED AREA OF 2862 SQUARE FEET - PCI SPREAD FOR FEATURE = 0.00  
 DESCRIPTION: TAXILANE**

3001 A            3001.101            5000            8-20-15            MJP            82            8  
 3001 A            3001.103            5000            8-20-15            MJP            75            8  
 3001 A            3001.104            5000            8-20-15            MJP            75            8  
 3001 A            3001.204            5000            8-20-15            MJP            80            8

**AVERAGE FEATURE PCI = 78  
 BASED ON A SAMPLED AREA OF 20000 SQUARE FEET - PCI SPREAD FOR FEATURE = 6.83  
 DESCRIPTION: RAMP**

3005 A            3005.107            4250            8-20-15            MJP            69            5 8 17  
 3005 A            3005.109            4250            8-20-15            MJP            77            8 16 17  
 3005 A            3005.111            4250            8-20-15            MJP            76            8 16 17  
 3005 A            3005.113            4250            8-20-15            MJP            70            8 10 12 17

**AVERAGE FEATURE PCI = 73  
 BASED ON A SAMPLED AREA OF 17000 SQUARE FEET - PCI SPREAD FOR FEATURE = 8.68  
 DESCRIPTION: RAMP**

3010 A            3010.106            3500            8-20-15            ABN            69            8 17  
 3010 A            3010.107            3500            8-20-15            ABN            71            8 16 17  
 3010 A            3010.108            3500            8-20-15            ABN            72            8 16

**AVERAGE FEATURE PCI = 70  
 BASED ON A SAMPLED AREA OF 10500 SQUARE FEET - PCI SPREAD FOR FEATURE = 2.81  
 DESCRIPTION: RAMP TAXIWAY**

3015 A            3015.101            5000            8-20-15            MJP            64            8 12  
 3015 A            3015.102            5000            8-20-15            MJP            71            8 12  
 3015 A            3015.104            5000            8-20-15            MJP            76            8  
 3015 A            3015.105            5000            8-20-15            MJP            75            8

**AVERAGE FEATURE PCI = 72  
 BASED ON A SAMPLED AREA OF 20000 SQUARE FEET - PCI SPREAD FOR FEATURE = 12.54  
 DESCRIPTION: RAMP**

3020 A            3020.308            2800            8-20-15            ABN            100  
 3020 A            3020.309            2800            8-20-15            ABN            100  
 3020 A            3020.311            2800            8-20-15            ABN            100  
 3020 A            3020.313            3010            8-20-15            ABN            100

**AVERAGE FEATURE PCI = 100  
 BASED ON A SAMPLED AREA OF 11410 SQUARE FEET - PCI SPREAD FOR FEATURE = 0.00  
 DESCRIPTION: RAMP**

3025 A            3025.300            2750            8-20-15            MJP            98            8  
 3025 A            3025.302            2750            8-20-15            MJP            94            8  
 3025 A            3025.305            2750            8-20-15            MJP            94            8  
 3025 A            3025.502            2750            8-20-15            MJP            100  
 3025 A            3025.505            2500            8-20-15            MJP            95            8

**AVERAGE FEATURE PCI = 96  
 BASED ON A SAMPLED AREA OF 13500 SQUARE FEET - PCI SPREAD FOR FEATURE = 5.75  
 DESCRIPTION: RAMP**

3050 P            3050.100            3300            8-20-15            MJP            85            2 3 13

**AVERAGE FEATURE PCI = 85  
 BASED ON A SAMPLED AREA OF 3300 SQUARE FEET - PCI SPREAD FOR FEATURE = 0.00  
 DESCRIPTION: RAMP**

3105 P            3105.100            3625            8-20-15            MJP            100  
 3105 P            3105.200            3625            8-20-15            MJP            100  
 3105 P            3105.300            3625            8-20-15            MJP            100

**AVERAGE FEATURE PCI = 100  
 BASED ON A SAMPLED AREA OF 10875 SQUARE FEET - PCI SPREAD FOR FEATURE = 0.00  
 DESCRIPTION: TEES**

FEATURE:	SAMPLE UNIT:	AREA:	DATE:	SURVEYED BY:	PCI:	DISTRESSES PRESENT:
5001 A	5001.106	3750	8-20-15	ARA	80	8 16
5001 A	5001.112	3750	8-20-15	ARA	81	8
5001 A	5001.118	3750	8-20-15	ARA	78	8
5001 A	5001.124	3750	8-20-15	ARA	75	8
5001 A	5001.130	3750	8-20-15	ARA	85	8
5001 A	5001.136	3750	8-20-15	ARA	80	8
5001 A	5001.142	3750	8-20-15	ARA	80	8
5001 A	5001.148	3750	8-20-15	ARA	79	8
5001 A	5001.151	3750	8-20-15	ARA	67	8 10*
5001 A	5001.154	3750	8-20-15	ARA	73	8
5001 A	5001.160	3750	8-20-15	ARA	76	8
5001 A	5001.166	3750	8-20-15	ARA	81	8
5001 A	5001.170	3750	8-20-15	ARA	66	5 8*

MEAN FEATURE PCI = 79

BASED ON A SAMPLED AREA OF 48750 SQUARE FEET - PCI SPREAD FOR FEATURE = 19.08

DESCRIPTION: RUNWAY 18-36

5010 A	5010.101	3750	8-20-15	ARA	74	8 10 17
5010 A	5010.104	3750	8-20-15	ARA	73	8 10 16 17
5010 A	5010.107	3750	8-20-15	ARA	85	8 10 17
5010 A	5010.110	3750	8-20-15	ARA	81	5 8 10 17
5010 A	5010.113	3750	8-20-15	ARA	82	8 10 17
5010 A	5010.114	3750	8-20-15	ARA	86	8 17

AVERAGE FEATURE PCI = 80

BASED ON A SAMPLED AREA OF 22500 SQUARE FEET - PCI SPREAD FOR FEATURE = 13.68

DESCRIPTION: RUNWAY 18-36

TOTAL NUMBER OF INSPECTED FEATURES = 16  
TOTAL NUMBER OF INSPECTED SAMPLE UNITS = 65

TOTAL AREA OF INSPECTED PAVEMENT = 242,897 S.F.

\* INDICATES "ADDITIONAL" SAMPLE UNITS.

## Appendix D. Distress Identification

This chapter describes pavement distress types commonly identified during airport PCI inspections.

### Rigid Pavement Distress

#### *Longitudinal, Transverse & Diagonal Cracking*

LTD cracking is often a result of load or temperature deformations. External loads cause flexure. Temperature changes can cause curling. When any of these stresses exceed the slab strength, cracking occurs.

LTD cracking is recorded at low, medium, or high severity, depending on the width of crack opening and degree of deterioration.

At low severity, a crack is less than 1/8 inch wide with little spalling, and no corrective action is indicated. At medium severity, LTD cracks can be up to 1 inch wide with moderate spalling and should be repaired using procedures similar to joint sealing. At high severity, cracks exceed 1 inch in width and may be severely spalled. High-severity LTD cracking is evidence of serious load failure, and correction may require patching or slab replacement. If distress occurs in several adjacent slabs at medium or high severity, major rehabilitation of that area is indicated.

A slab divided into four or more pieces is said to be “divided” or “shattered.” Shattered slab is a separate distress category and indicates a significant structural failure. A shattered slab has lost its ability to distribute loads. Shattered slabs are rated in three severities, but the recommended action in any case is slab replacement.



### Shrinkage Cracking

Shrinkage cracks are small, non-working cracks visible at the pavement surface but not penetrating the full depth of concrete. Shrinkage cracks most commonly occur shortly after construction due to concrete shrinkage during the curing process.

Shrinkage cracks are usually so small that they are not visible until staining or loss of material at crack edges begins to take place. Shrinkage cracks do not represent structural weakness, and no corrective action is prescribed.



### Durability Cracking

Durability cracking (D-cracking) is caused by environmental factors, the most common being freeze/thaw. D-cracking usually appears as either a pattern of hairline cracks running parallel to a joint or crack, or in a corner, where water tends to collect. D-cracking eventually leads to disintegration of the pavement, creating foreign object damage (FOD) potential.

At low severity, D-cracking is evident, but no disintegration has occurred. Medium severity is evident over a significant area of the slab, and some disintegration and FOD potential exist. High-severity D-cracking is evidenced by extensive cracking with loose and missing pieces and significant FOD potential.





### *Joint Spall and Corner Spall*

Spalls at slab joints and corners are caused by excessive internal stress in the pavement. Spalls occur when these stresses exceed the shear strength of the concrete.

Spalling usually results from thermal expansion during hot weather when slabs push and expand against one another. If the joints are filled with incompressible material, such as sand, stresses can become severe, causing spalls. Spalling can be reduced significantly by maintenance of joint sealant.

Spall repair requires patching. The extent and severity of spalling suggests the appropriate action. At low severity, spalled concrete remains securely in place in the slab. A low-severity spall should be monitored closely for further deterioration and should be patched when spalled particles become loose, or during the next scheduled patching activity. Medium- and high-severity spalls should be repaired immediately to prevent FOD. If the pavement can be restored to serviceable condition, spalls should be patched for long-term service. If the pavement is beyond repair, temporary patching should be considered to control FOD.



### *Patches, Large and Small*

Large and small patches, by PCI inspection criteria, are distress conditions. Patches indicate deterioration and aging of pavement that contributes to shortened service life. However, patching also indicates that pavement is being maintained.

A patch that is performing well and shows no outward distress is recorded at low severity, and no corrective action is required. Medium-severity patches are serviceable but are beginning to deteriorate. Maintenance or replacement is indicated. At high severity, replacement is indicated.

By definition, small patches are smaller than 5 square feet in surface area, and they usually result from spall repair at slab joints and corners.

Large patches also may be the result of spall repair, but they often indicate more serious deficiencies, such as corner breaks or other full-depth failure smaller than panel size.



## Joint Seal Damage

When joint sealant is in perfect condition (no damage), there is no distress.

At low severity, at least 10 percent of the sealant is debonded but still in contact with the joint edges. Medium-severity joint seal damage is recorded when at least 10 percent of the sealant has visible gaps smaller than 1/8 inch and is an indicator that replacement should be programmed as soon as is practical. In the meantime, aggressive inspection and sustaining maintenance is recommended to minimize subsurface damage from moisture penetration. At high severity, visible gaps exceed 1/8 inch, and the amount and degree of joint seal damage typically requires complete removal and replacement of the existing sealant.

On serviceable pavement, deteriorated joint sealant should be repaired or replaced to preserve pavement and subgrade integrity and prolong service life. The issue is not so clear-cut with unserviceable pavement. Pavement that can be restored to serviceable condition by maintenance activities such as patching and joint seal repair, or by slab replacement, should be so maintained as long as the process is cost-effective. However, when age and condition preclude economical return to serviceable condition by such means, joint seal repair would no longer be cost-effective and should be suspended except for an interim maintenance program to control FOD potential.



## Flexible Pavement Distress

### *Longitudinal & Transverse Cracking*

L&T cracks are caused by age, construction, and subsurface conditions. Age-related cracking occurs as oxidizing pavement loses components to the atmosphere and becomes more brittle. Consistent application of seal coats can help to prevent age-related cracks.

Construction-related cracking often develops along paving joints. Ensuring that joints are made when both sides are still hot, and near the same temperature, is one of the best ways to mitigate this potential problem.

Seasonal movement caused by changes in subsurface moisture or temperature differences also can cause pavement cracking. Asphalt pavement placed over a PCC pavement or cement stabilized base course may evidence reflective cracking from the underlying material. Wheel loads do not cause L&T cracks, although traffic may worsen their condition.

Low-severity L&T cracks are less than ¼ inch wide, or if sealed with suitable filler material in satisfactory condition can be any width less than 3 inches, if they are not spalled. Maintenance usually is not indicated for low-severity cracking. Moderately spalled cracks and cracks wider than ¼ inch which are not satisfactorily sealed are at medium severity. Medium-severity cracks should be sealed with a high-quality crack filling material. Severely spalled cracks and cracks wider than 3 inches are at high severity. High-severity L&T cracks normally require patching.



## Alligator Cracking

Alligator cracks are a series of interconnected load-related cracks caused by fatigue of the asphalt surface. Alligator cracking is a significant structural distress and develops only in places subject to traffic loads. These cracks typically initiate at the bottom of the asphalt layer and propagate upward. Once a fatigue crack is visible at the surface, significant damage has already occurred.

At low severity, alligator cracks are evidenced by a series of parallel hairline cracks (usually in a wheel path). Medium-severity alligator cracking is a well-defined pattern of interconnected cracks, and some spalling may be present. High-severity alligator cracks have lost aggregate interlock between adjacent pieces, and the cracks may be severely spalled with FOD potential. Most likely, the pieces will move freely under traffic.

Alligator cracking is a serious structural failure that cannot be repaired with sealant. The proper repair is patching.



### Raveling/Weathering

Raveling and weathering are the wearing away of the pavement surface. Failure can be caused by the dislodging of aggregate particles or the loss of asphalt binder. These distresses are usually evident over large areas and may indicate that the asphalt binder has hardened significantly.

Raveling is the loss of coarse aggregate, weathering is the loss of fine aggregate or binder.

Raveling: At low severity, 5 to 20 coarse aggregate particles are missing per square yard. Medium severity is defined by 20 to 40 missing coarse aggregate particles per square yard. At high severity, more than 40 coarse aggregate particles are missing per square yard, and the top layer of aggregate has eroded away.

Weathering: At low severity, edges of coarse aggregate are exposed less than 1 mm. At medium severity, loss of fine aggregate is noticeable and edges of coarse aggregate are exposed up to 6 mm (1/4 inch). High severity weathering has edges of coarse aggregate exposed > 6 mm, with considerable loss of fine aggregate matrix and potential for loss of coarse aggregate.



### Rutting

Ruts are localized areas of pavement having elevations lower than the surrounding sections.

Rutting is due to base and subgrade consolidation caused by excessive wheel loads or poor compaction. Ruts indicate structural failure and can cause hydroplaning.

At low severity, ruts have an average depth of ¼ to ½ inches. At medium severity, ruts have an average depth of ½ to 1 inch. At high severity, ruts have an average depth greater than 1 inch. Patching is the appropriate repair for ruts.



## Appendix E. Feature Analysis

### Pavement Performance Models

Projected performance is determined by relating current pavement condition to expected pavement condition. Projected performance varies based on pavement type. There are four pavement types in Indiana: AC, PCC, AAC, and APC. Each pavement type has a unique deterioration curve, created by plotting all data for that group as PCI vs. age and then finding a performance curve to best fit the data. These curves represent the historic performance of pavement in the group and become the baseline for future projections. The baseline curves are modeled with a third order polynomial equation as shown below.

$$PCI = X(\text{Age})^3 + Y(\text{Age})^2 + Z(\text{Age})^1 + C$$

#### Current Condition (rotating the curves)

Starting with the baseline curve for comparison, current pavement condition is plotted, and the baseline curve is rotated to meet the current condition. The rotated curve provides the starting point for projecting the future pavement condition.

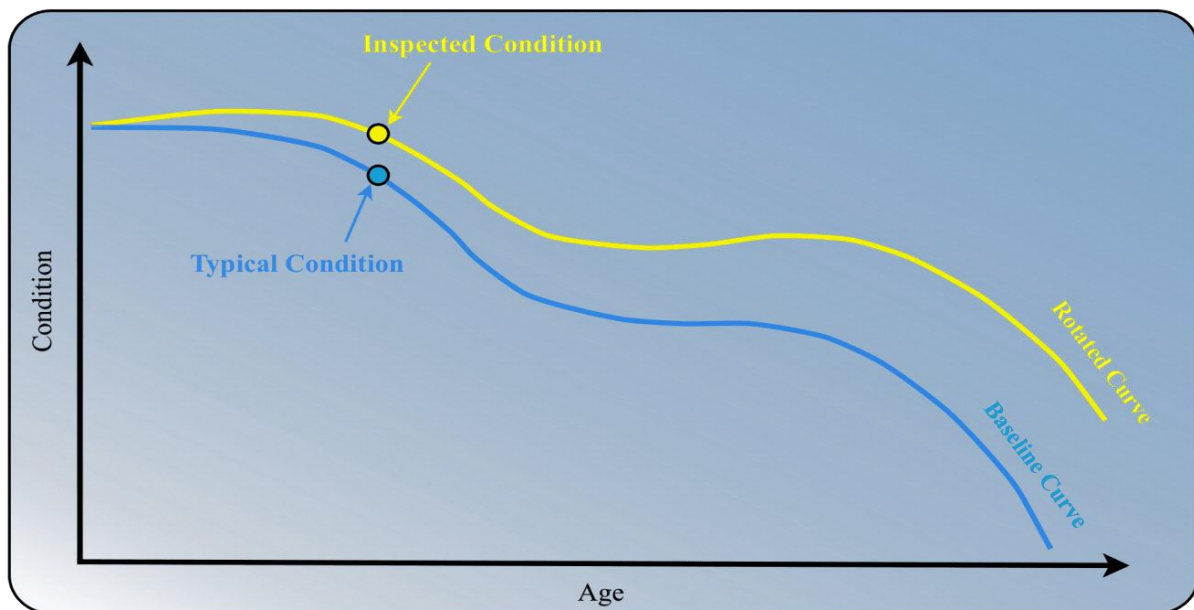

#### Advanced Analysis (accounting for distress)

Some types of pavement distress have a greater impact on pavement deterioration than others. Rutting and alligator (fatigue) cracking are major structural failures and can lead to rapid pavement deterioration. Other distress types, like L&T cracking, develop slowly over time and typically do not cause a significant deviation from the baseline curve.

After current condition is accounted for with the curve rotation, pavement distress is addressed in the advanced analysis by compressing or expanding the baseline curve to account for the expected rate of pavement deterioration.

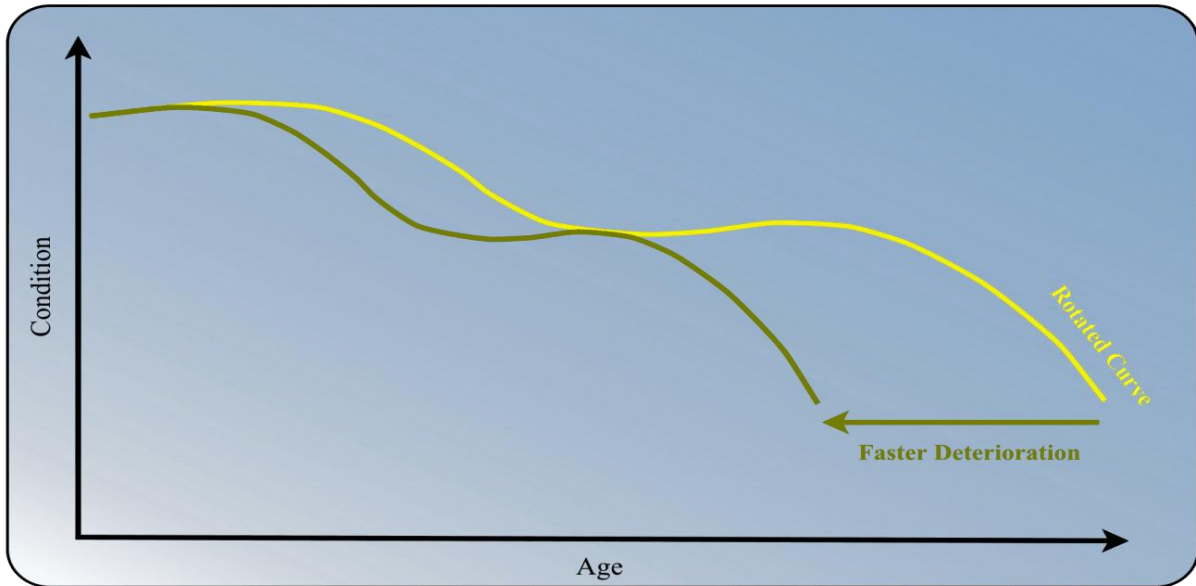

**Projected PCI (near term vs. longer term)**

Projecting pavement condition with advanced analysis is a combination of rotating, expanding, and contracting the baseline curves. This projection method provides good short-term results for all pavement sections and fair long-term projections on pavement sections with conditions near the baseline model. The long-term accuracy of outlier data is discussed on the following page.

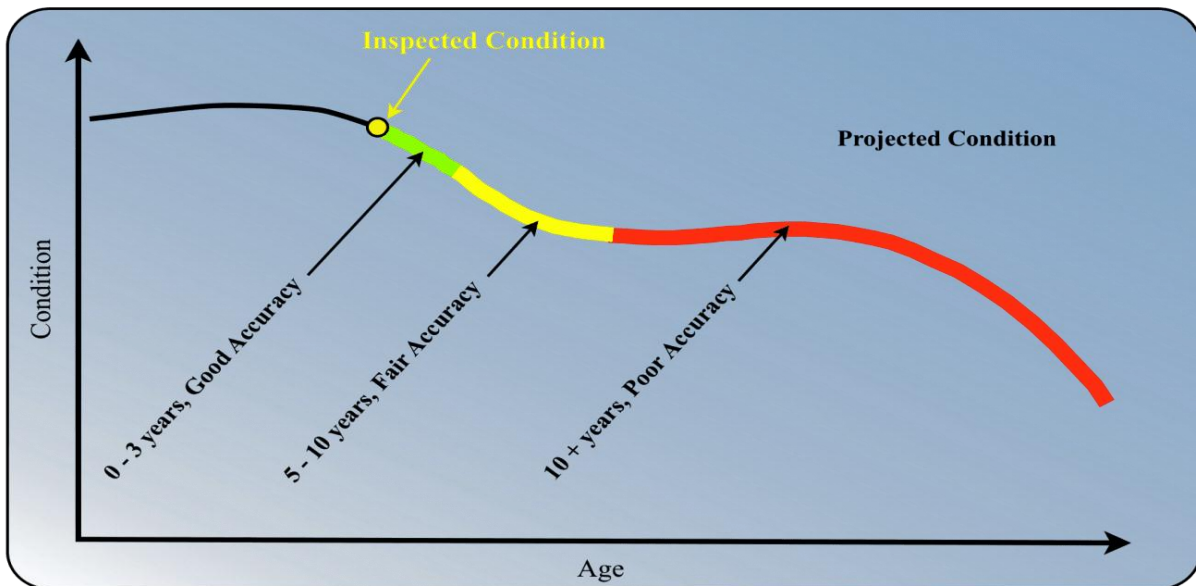



**Projected PCI (why some features have unexpected projections)**

Long-term PCI projections can be very useful for planning purposes. However, projections in excess of 10 years are well beyond the intended scope of the PCI procedure. FAA Advisory Circular 150/5380-6B establishes a maximum 3-year interval between detailed PCI surveys.

Curve rotation, expansion, and contraction are performed to produce the best possible accuracy of future pavement condition over the next 3 to 5 years. This methodology can overemphasize certain performance trends in the long term. This is especially true for outlier data, such as pavement features that are performing much better or worse than is typical.

The curve below shows an example of a performance trend being overemphasized in the long-term projection. Because the pavement feature is performing much better than the baseline curve, the long-term projection shows the pavement lasting an additional 30+ years before reaching the MSL. Rotation of the curve to provide the most accurate projection over 3 to 5 years has resulted in a long-term projection that is likely unrealistic.

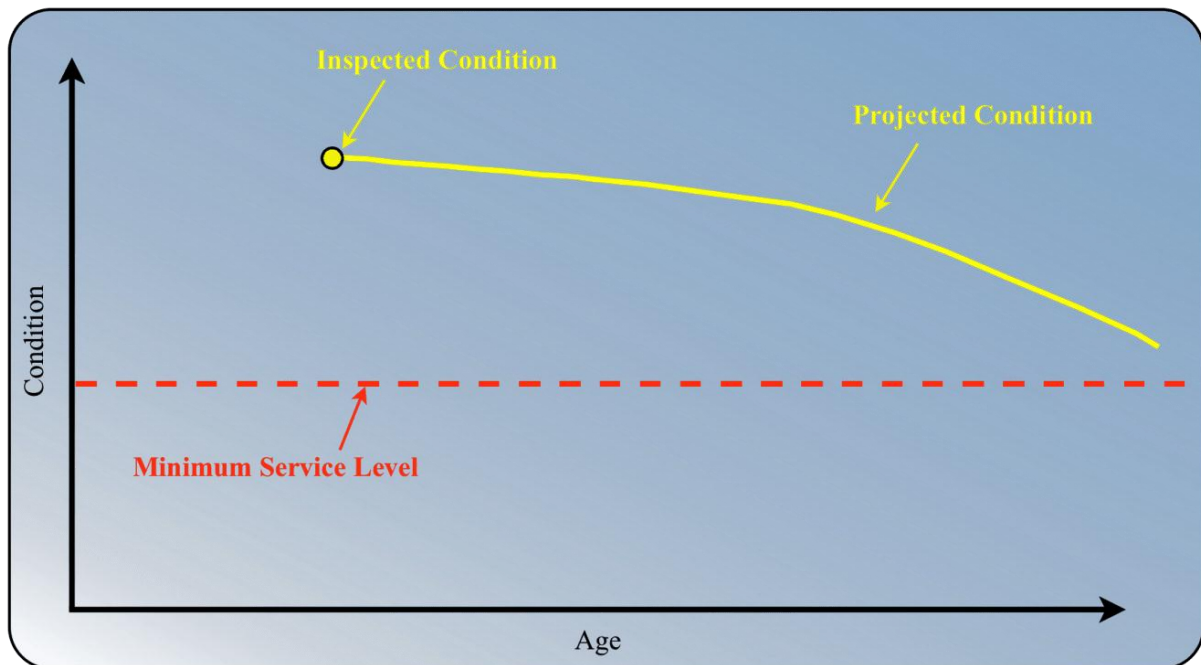

When long-term projections such as this are encountered, airport managers should not rely on projections in excess of 10 years. Managers can be confident that the pavement is performing much better than average and will not require rehabilitation within the current 5-year CIP planning window. As new distress develops over time, future PCI surveys will determine the ideal timing for rehabilitation.

## Feature Analysis

As part of the PCI evaluation, a detailed analysis is presented for each airside pavement feature using the two-page format depicted below.

### Page 1

The first page of the analysis is a feature summary. Located near the top left-hand corner is the feature number and pavement description. Construction history and inspector comments are listed below, along with a photo of the pavement section if available. Distress totals recorded during the PCI survey are listed next, and an approximation of the cause of the pavement deterioration is shown at the bottom. If the pavement is projected to fall below the desired MSL during the next 12 years, the analysis year will be shown along with the optimum year for pavement rehabilitation.

AIRPAV

AIRPORT: BLOOMINGTON/MONROE COUNTY

AIRPAV FEATURE ANALYSIS PROGRAM OUTPUT

FEATURE: 5007

ANALYSIS YEAR: 2011    **OPTIMIZED FOR: 2019**

PAVEMENT TYPE: AC

FEATURE AREA: 1,278,750

INSPECTED AREA: 40,000

MINIMUM SERVICE LEVEL: .65

DESCRIPTION: RUNWAY 17-35 KEEL

INSPECTION DATE: 8-11-11

FEATURE'S HIGH PCI: 72

FEATURE'S LOW PCI: 59

AVERAGE PCI: 69 GOOD

ESTIMATED PCI IS: 65 in 2019

COMMENTS/HISTORY FOR FEATURE 5007, RUNWAY 17-35 KEEL

1989: 4" P401 / 5" P401 / 13" P209

**DISTRESS QUANTITIES FOR FEATURE 5007**

DISTRESS TYPE	SEVERITY	MEASURED QUANTITY	ESTIMATED TOTAL QUANTITY	UNITS	PERCENTAGE OF AIR DISTRESS
ALLIGATOR CRACKING	LOW	66	2,109	S.F.	8.3
LONG & TRANS. CRACK	MED	995	31,868	L.F.	38.4
LONG & TRANS. CRACK	LOW	2,824	90,279	L.F.	34.8
RAVELING/WEATHERING	LOW	9,450	302,104	S.F.	26.3

**BASIC DISTRESS CAUSES**

APPROXIMATE AMOUNT OF DISTRESS RELATED TO LOAD ON THE PAVEMENT IS: 8 %

APPROXIMATE AMOUNT OF DISTRESS RELATED TO MATERIALS PROBLEMS IN THE FEATURE IS: 52 %

APPROXIMATE AMOUNT OF DISTRESS RELATED TO AGE OF PAVEMENT AND TRAFFIC REPETITIONS IS: 39 %

PAGE 1

**Description & Feature #**

**Optimized Rehab Year**

**Construction History**

**Distress Totals**

The second page is a graphic analysis of pavement deterioration. Pavement deterioration is forecast based on historic deterioration of similar Indiana pavement types. Remaining life is projected by stretching and rotating the baseline curves to fit the current condition determined from the PCI survey.

When pavement condition drops below the desired MSL, the software selects rehabilitation actions that address the cause of the pavement failure while restoring the pavement to a condition above the MSL. A NO ACTION recommendation indicates that the feature is expected to remain serviceable during the 12-year forecasting period without major repairs. NO ACTION recommendations do not diminish the need for regular maintenance.

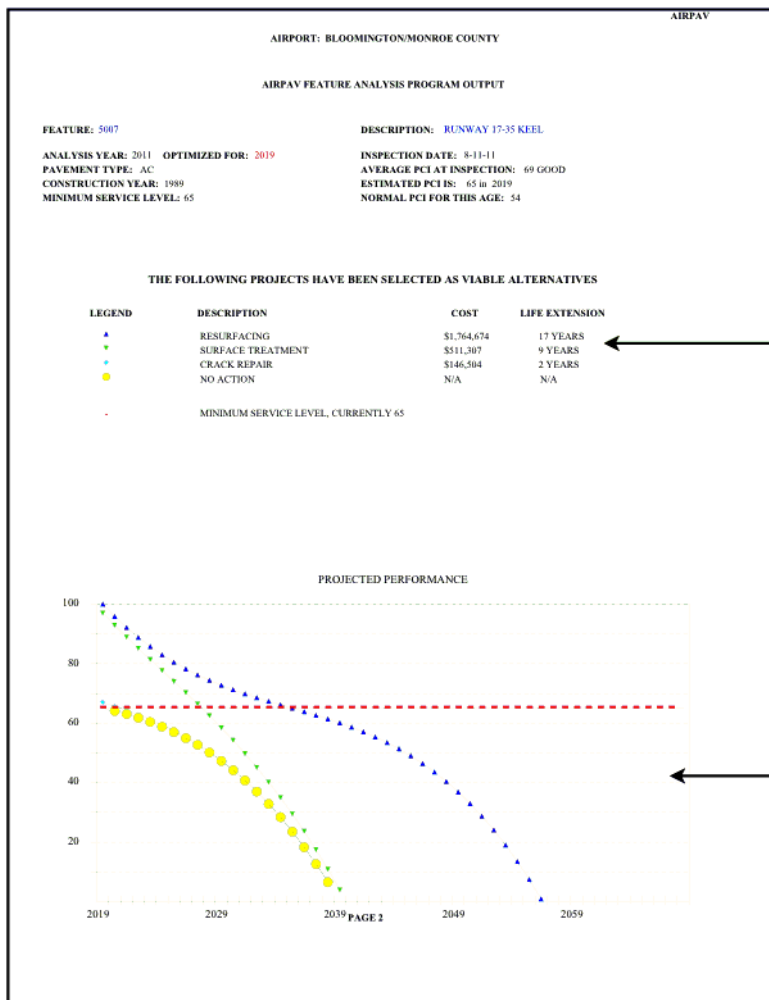

**Recommended Actions**

**Graphic Analysis**

## AIRPORT: SULLIVAN COUNTY

## AIRPAV FEATURE ANALYSIS PROGRAM OUTPUT

FEATURE: 101

DESCRIPTION: PARALLEL TAXIWAY

ANALYSIS YEAR: 2015

INSPECTION DATE: 8-20-15

PAVEMENT TYPE: AC

FEATURE'S HIGH PCI: 79

FEATURE AREA: 20,600

FEATURE'S LOW PCI: 76

INSPECTED AREA: 10,500

AVERAGE PCI: 77 SATISFACTORY

MINIMUM SERVICE LEVEL: 50

ESTIMATED PCI IS: 77 in 2015

## COMMENTS/HISTORY FOR FEATURE 101, PARALLEL TAXIWAY

2004: 1.5" p401 / p603 / EXISTING  
 UNKNOWN EMULSION SEAL  
 1975 2.5" P401  
 1966 2 INCH P401 / 6 INCH P208 / 5 INCH P154

## DISTRESS QUANTITIES FOR FEATURE 101

DISTRESS TYPE	SEVERITY	MEASURED QUANTITY	ESTIMATED TOTAL QUANTITY	UNITS	PERCENTAGE OF All DISTRESS
LONG.& TRANS. CRACK	MED	42	82	L.F.	27.6
LONG.& TRANS. CRACK	LOW	667	1,308	L.F.	69.7
WEATHERING	LOW	500	980	S.F.	2.5

## BASIC DISTRESS CAUSES

APPROXIMATE AMOUNT OF DISTRESS RELATED TO LOAD ON THE PAVEMENT IS: 0 %  
 APPROXIMATE AMOUNT OF DISTRESS RELATED TO MATERIALS PROBLEMS IN THE FEATURE IS: 66 %  
 APPROXIMATE AMOUNT OF DISTRESS RELATED TO AGE OF PAVEMENT AND TRAFFIC REPETITIONS IS: 34 %



AIRPORT: SULLIVAN COUNTY

AIRPAV FEATURE ANALYSIS PROGRAM OUTPUT

FEATURE: 101

DESCRIPTION: PARALLEL TAXIWAY

ANALYSIS YEAR: 2015

INSPECTION DATE: 8-20-15

PAVEMENT TYPE: AC

AVERAGE PCI AT INSPECTION: 77 SATISFACTORY

CONSTRUCTION YEAR: 2004

ESTIMATED PCI IS: 77 in 2015

MINIMUM SERVICE LEVEL: 50

NORMAL PCI FOR THIS AGE: 74

THE FOLLOWING PROJECTS HAVE BEEN SELECTED AS VIABLE ALTERNATIVES

LEGEND	DESCRIPTION	COST	LIFE EXTENSION
●	NO ACTION	N/A	N/A
-	MINIMUM SERVICE LEVEL, CURRENTLY 50		

PROJECTED PERFORMANCE

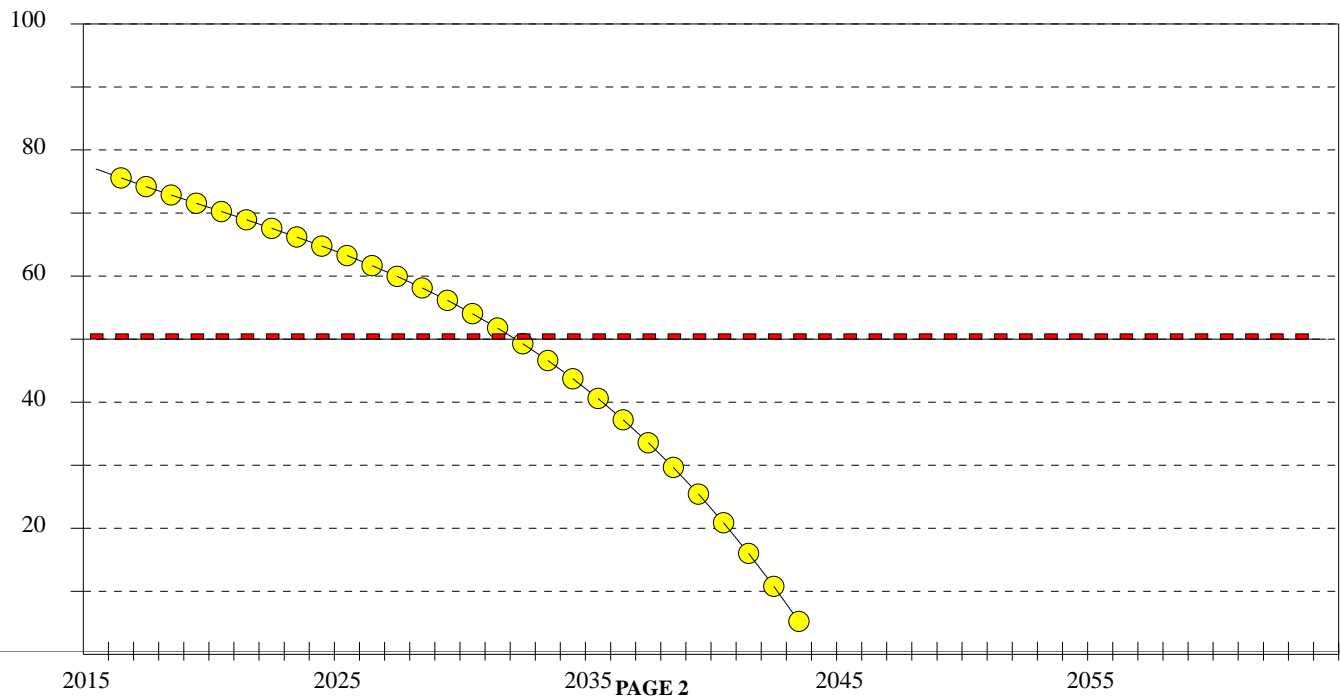

## AIRPORT: SULLIVAN COUNTY

## AIRPAV FEATURE ANALYSIS PROGRAM OUTPUT

FEATURE: 110

DESCRIPTION: PARALLEL TAXIWAY

ANALYSIS YEAR: 2015

INSPECTION DATE: 8-20-15

PAVEMENT TYPE: AC

FEATURE'S HIGH PCI: 90

FEATURE AREA: 36,515

FEATURE'S LOW PCI: 70

INSPECTED AREA: 13,200

AVERAGE PCI: 80 SATISFACTORY

MINIMUM SERVICE LEVEL: 50

ESTIMATED PCI IS: 80 in 2015

## COMMENTS/HISTORY FOR FEATURE 110, PARALLEL TAXIWAY

2002: 1.25" P401 (1/2" Max agg.)  
 / 2.75" P401 (1.5" Max Agg.)  
 / 8" P209 / P603  
 \*

## DISTRESS QUANTITIES FOR FEATURE 110

DISTRESS TYPE	SEVERITY	MEASURED QUANTITY	ESTIMATED TOTAL QUANTITY	UNITS	PERCENTAGE OF All DISTRESS
ALLIGATOR CRACKING	LOW	24	66	S.F.	27.4
LONG.& TRANS. CRACK	MED	168	464	L.F.	42.5
LONG.& TRANS. CRACK	LOW	246	680	L.F.	24.7
WEATHERING	MED	110	304	S.F.	1.4
WEATHERING	LOW	1,100	3,042	S.F.	3.8

## BASIC DISTRESS CAUSES

APPROXIMATE AMOUNT OF DISTRESS RELATED TO LOAD ON THE PAVEMENT IS:	27 %
APPROXIMATE AMOUNT OF DISTRESS RELATED TO MATERIALS PROBLEMS IN THE FEATURE IS:	47 %
APPROXIMATE AMOUNT OF DISTRESS RELATED TO AGE OF PAVEMENT AND TRAFFIC REPETITIONS IS:	26 %



AIRPORT: SULLIVAN COUNTY

AIRPAV FEATURE ANALYSIS PROGRAM OUTPUT

FEATURE: 110

DESCRIPTION: PARALLEL TAXIWAY

ANALYSIS YEAR: 2015

INSPECTION DATE: 8-20-15

PAVEMENT TYPE: AC

AVERAGE PCI AT INSPECTION: 80 SATISFACTORY

CONSTRUCTION YEAR: 2002

ESTIMATED PCI IS: 80 in 2015

MINIMUM SERVICE LEVEL: 50

NORMAL PCI FOR THIS AGE: 71

THE FOLLOWING PROJECTS HAVE BEEN SELECTED AS VIABLE ALTERNATIVES

LEGEND	DESCRIPTION	COST	LIFE EXTENSION
●	NO ACTION	N/A	N/A
-	MINIMUM SERVICE LEVEL, CURRENTLY 50		

PROJECTED PERFORMANCE

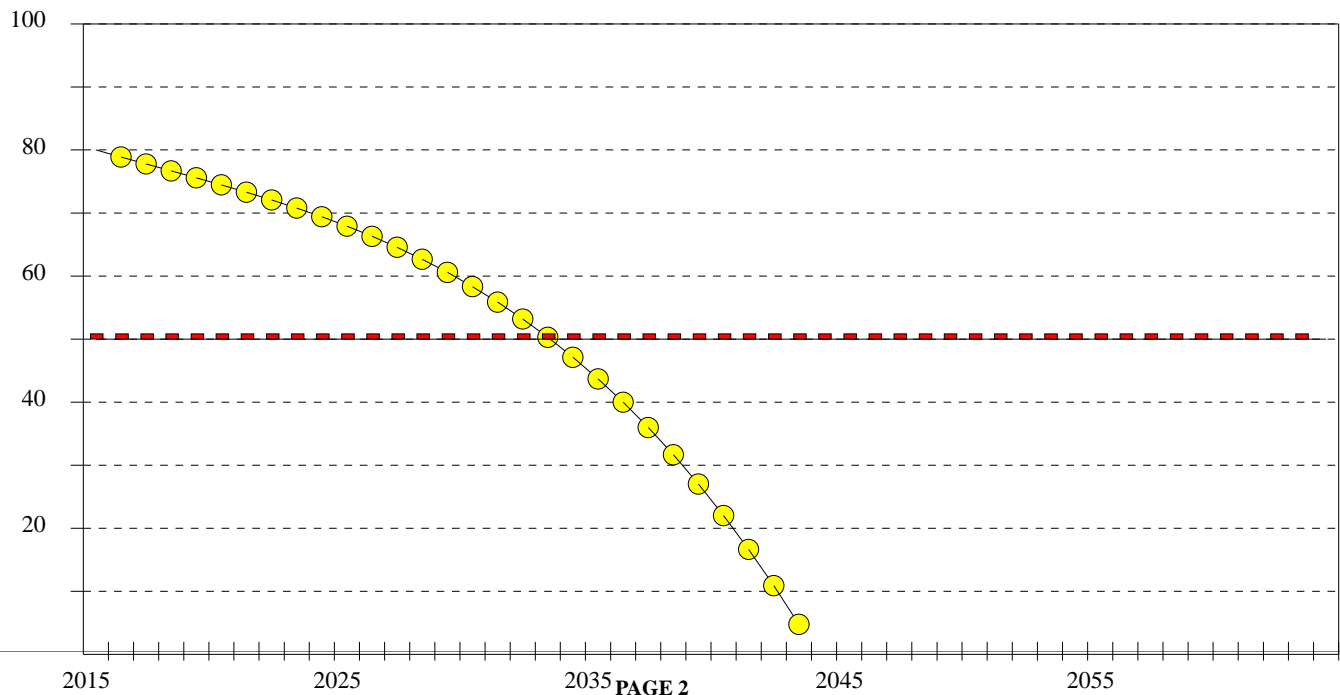

## AIRPORT: SULLIVAN COUNTY

## AIRPAV FEATURE ANALYSIS PROGRAM OUTPUT

<b>FEATURE:</b> 201	<b>DESCRIPTION:</b> PARALLEL TAXIWAY
<b>ANALYSIS YEAR:</b> 2015	<b>INSPECTION DATE:</b> 8-20-15
<b>PAVEMENT TYPE:</b> AC OVERLAY	<b>FEATURE'S HIGH PCI:</b> 72
<b>FEATURE AREA:</b> 86,356	<b>FEATURE'S LOW PCI:</b> 68
<b>INSPECTED AREA:</b> 24,500	<b>AVERAGE PCI:</b> 70 FAIR
<b>MINIMUM SERVICE LEVEL:</b> 50	<b>ESTIMATED PCI IS:</b> 70 in 2015

## COMMENTS/HISTORY FOR FEATURE 201, PARALLEL TAXIWAY

2004: 1.5" p401 / p603 / EXISTING  
 UNKNOWN EMULSION SEAL  
 1975: 2.5" P401 / 4 INCH P201 / 5 INCH P154  
 \*

## DISTRESS QUANTITIES FOR FEATURE 201

DISTRESS TYPE	SEVERITY	MEASURED QUANTITY	ESTIMATED TOTAL QUANTITY	UNITS	PERCENTAGE OF All DISTRESS
BLOCK CRACKING	LOW	510	1,797	S.F.	8.4
DEPRESSION	LOW	20	70	S.F.	1.4
LONG.& TRANS. CRACK	MED	6	21	L.F.	3.5
LONG.& TRANS. CRACK	LOW	3,094	10,905	L.F.	81
WEATHERING	LOW	3,700	13,041	S.F.	5.4

## BASIC DISTRESS CAUSES

APPROXIMATE AMOUNT OF DISTRESS RELATED TO LOAD ON THE PAVEMENT IS:	0 %
APPROXIMATE AMOUNT OF DISTRESS RELATED TO MATERIALS PROBLEMS IN THE FEATURE IS:	60 %
APPROXIMATE AMOUNT OF DISTRESS RELATED TO AGE OF PAVEMENT AND TRAFFIC REPETITIONS IS:	40 %





AIRPORT: SULLIVAN COUNTY

AIRPAV FEATURE ANALYSIS PROGRAM OUTPUT

FEATURE: 201

DESCRIPTION: PARALLEL TAXIWAY

ANALYSIS YEAR: 2015

INSPECTION DATE: 8-20-15

PAVEMENT TYPE: AC OVERLAY

AVERAGE PCI AT INSPECTION: 70 FAIR

CONSTRUCTION YEAR: 2004

ESTIMATED PCI IS: 70 in 2015

MINIMUM SERVICE LEVEL: 50

NORMAL PCI FOR THIS AGE: 72

THE FOLLOWING PROJECTS HAVE BEEN SELECTED AS VIABLE ALTERNATIVES

LEGEND	DESCRIPTION	COST	LIFE EXTENSION
●	NO ACTION	N/A	N/A
-	MINIMUM SERVICE LEVEL, CURRENTLY 50		

PROJECTED PERFORMANCE

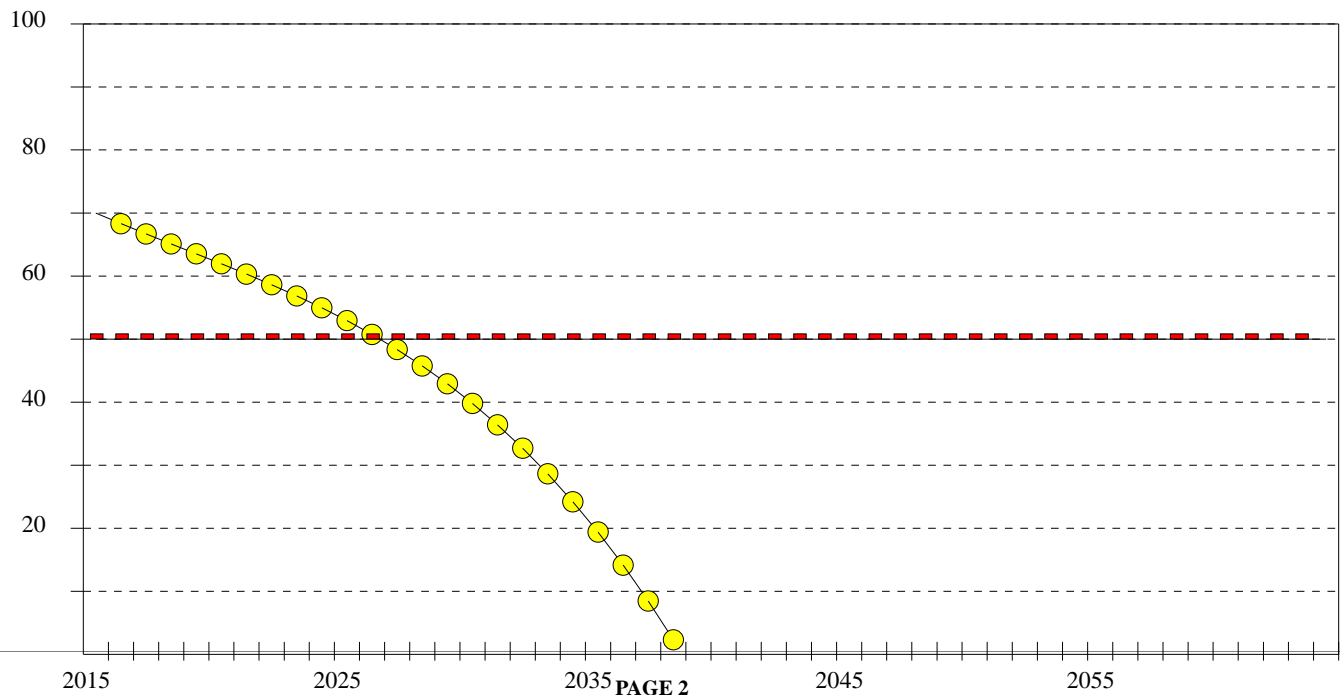

## AIRPORT: SULLIVAN COUNTY

## AIRPAV FEATURE ANALYSIS PROGRAM OUTPUT

<b>FEATURE:</b> 301	<b>DESCRIPTION:</b> NORTH LOOP TWY
<b>ANALYSIS YEAR:</b> 2015	<b>INSPECTION DATE:</b> 8-20-15
<b>PAVEMENT TYPE:</b> AC OVERLAY	<b>FEATURE'S HIGH PCI:</b> 70
<b>FEATURE AREA:</b> 12,932	<b>FEATURE'S LOW PCI:</b> 69
<b>INSPECTED AREA:</b> 8,400	<b>AVERAGE PCI:</b> 70 FAIR
<b>MINIMUM SERVICE LEVEL:</b> 50	<b>ESTIMATED PCI IS:</b> 70 in 2015

## COMMENTS/HISTORY FOR FEATURE 301, NORTH LOOP TWY

2004: 1.5" p401 / p603 / EXISTING  
 UNKNOWN EMULSION SEAL  
 1975 2.5" P401  
 1966 2 INCH P401 / 6 INCH P208 / 5 INCH P154

## DISTRESS QUANTITIES FOR FEATURE 301

DISTRESS TYPE	SEVERITY	MEASURED QUANTITY	ESTIMATED TOTAL QUANTITY	UNITS	PERCENTAGE OF All DISTRESS
LONG.& TRANS. CRACK	MED	37	56	L.F.	21.6
LONG.& TRANS. CRACK	LOW	920	1,416	L.F.	74.6
WEATHERING	LOW	810	1,247	S.F.	3.7

## BASIC DISTRESS CAUSES

APPROXIMATE AMOUNT OF DISTRESS RELATED TO LOAD ON THE PAVEMENT IS:	0 %
APPROXIMATE AMOUNT OF DISTRESS RELATED TO MATERIALS PROBLEMS IN THE FEATURE IS:	65 %
APPROXIMATE AMOUNT OF DISTRESS RELATED TO AGE OF PAVEMENT AND TRAFFIC REPETITIONS IS:	35 %



AIRPORT: SULLIVAN COUNTY

AIRPAV FEATURE ANALYSIS PROGRAM OUTPUT

FEATURE: 301

DESCRIPTION: NORTH LOOP TWY

ANALYSIS YEAR: 2015

INSPECTION DATE: 8-20-15

PAVEMENT TYPE: AC OVERLAY

AVERAGE PCI AT INSPECTION: 70 FAIR

CONSTRUCTION YEAR: 2004

ESTIMATED PCI IS: 70 in 2015

MINIMUM SERVICE LEVEL: 50

NORMAL PCI FOR THIS AGE: 72

THE FOLLOWING PROJECTS HAVE BEEN SELECTED AS VIABLE ALTERNATIVES

LEGEND	DESCRIPTION	COST	LIFE EXTENSION
●	NO ACTION	N/A	N/A
-	MINIMUM SERVICE LEVEL, CURRENTLY 50		

PROJECTED PERFORMANCE

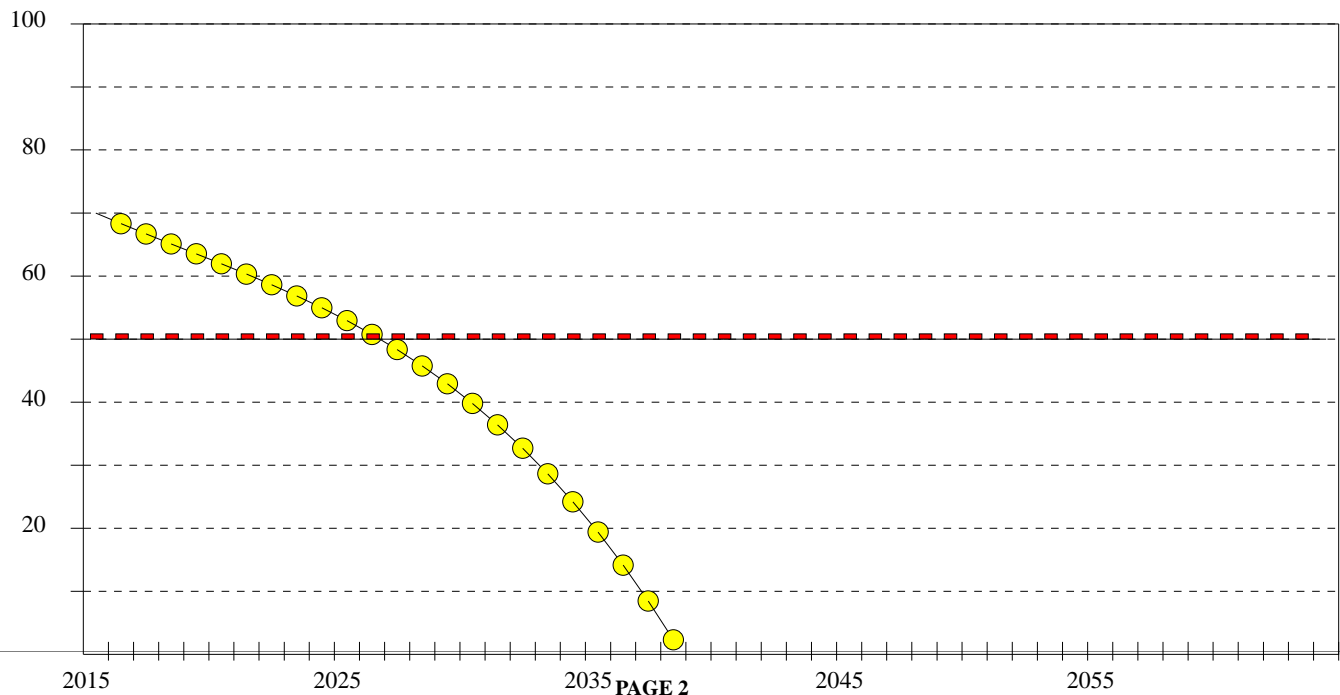

## AIRPORT: SULLIVAN COUNTY

## AIRPAV FEATURE ANALYSIS PROGRAM OUTPUT

FEATURE: 405

DESCRIPTION: RAMP CONNECTOR

ANALYSIS YEAR: 2015

INSPECTION DATE: 8-20-15

PAVEMENT TYPE: AC -

FEATURE'S HIGH PCI: 68

FEATURE AREA: 5,600

FEATURE'S LOW PCI: 68

INSPECTED AREA: 5,600

AVERAGE PCI: 68 FAIR

MINIMUM SERVICE LEVEL: 50

ESTIMATED PCI IS: 68 in 2015

## COMMENTS/HISTORY FOR FEATURE 405, RAMP CONNECTOR

2004: 1.5" p401 / 1.5" p401 / p603 / 2.5"-4.5" RECYCLED AC  
 UNKNOWN EMULSION SEAL  
 1975: 2.5" P401  
 1966: 2" P401 / 6" P208 / 5" P154

## DISTRESS QUANTITIES FOR FEATURE 405

DISTRESS TYPE	SEVERITY	MEASURED QUANTITY	ESTIMATED TOTAL QUANTITY	UNITS	PERCENTAGE OF All DISTRESS
LONG.& TRANS. CRACK	MED	25	25	L.F.	20.8
LONG.& TRANS. CRACK	LOW	718	718	L.F.	77.1
WEATHERING	LOW	300	300	S.F.	2

## BASIC DISTRESS CAUSES

APPROXIMATE AMOUNT OF DISTRESS RELATED TO LOAD ON THE PAVEMENT IS: 0 %  
 APPROXIMATE AMOUNT OF DISTRESS RELATED TO MATERIALS PROBLEMS IN THE FEATURE IS: 66 %  
 APPROXIMATE AMOUNT OF DISTRESS RELATED TO AGE OF PAVEMENT AND TRAFFIC REPETITIONS IS: 34 %



AIRPORT: SULLIVAN COUNTY

AIRPAV FEATURE ANALYSIS PROGRAM OUTPUT

FEATURE: 405

DESCRIPTION: RAMP CONNECTOR

ANALYSIS YEAR: 2015

INSPECTION DATE: 8-20-15

PAVEMENT TYPE: AC -

AVERAGE PCI AT INSPECTION: 68 FAIR

CONSTRUCTION YEAR: 2004

ESTIMATED PCI IS: 68 in 2015

MINIMUM SERVICE LEVEL: 50

NORMAL PCI FOR THIS AGE: 57

THE FOLLOWING PROJECTS HAVE BEEN SELECTED AS VIABLE ALTERNATIVES

LEGEND	DESCRIPTION	COST	LIFE EXTENSION
●	NO ACTION	N/A	N/A
-	MINIMUM SERVICE LEVEL, CURRENTLY 50		

PROJECTED PERFORMANCE

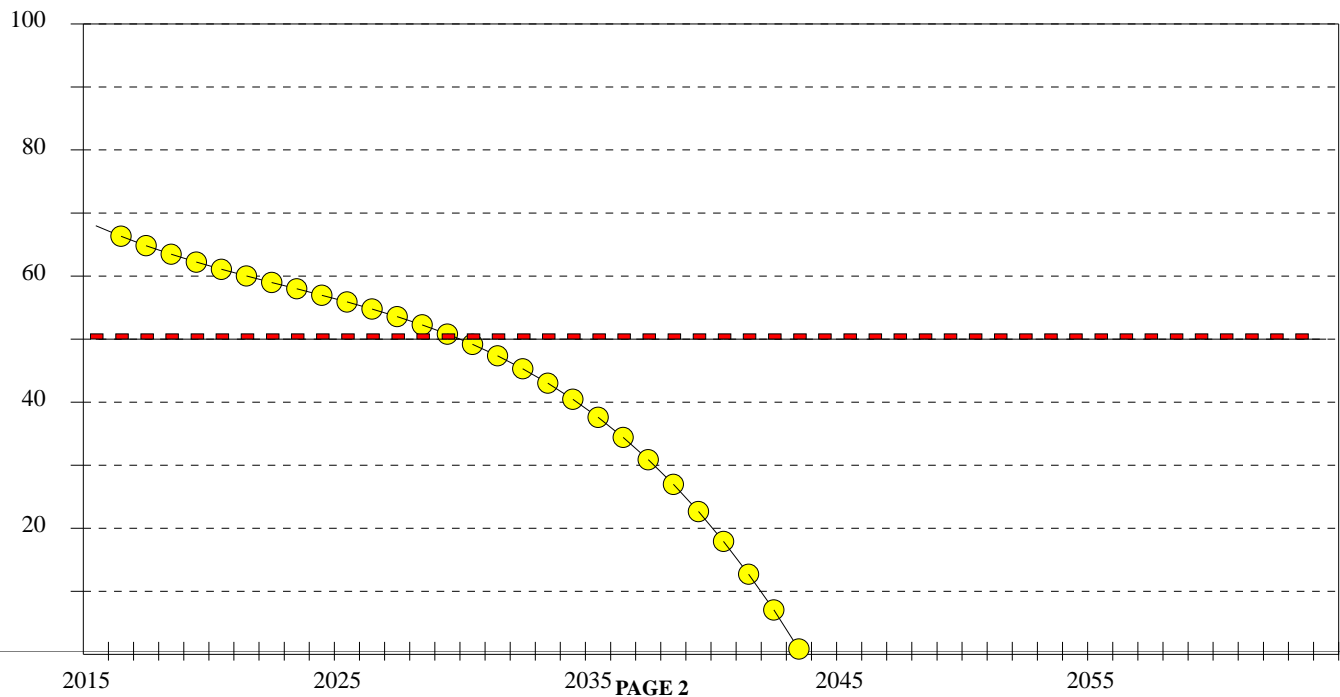

## AIRPORT: SULLIVAN COUNTY

## AIRPAV FEATURE ANALYSIS PROGRAM OUTPUT

<b>FEATURE:</b> 505	<b>DESCRIPTION:</b> TAXILANE
<b>ANALYSIS YEAR:</b> 2015 <b>OPTIMIZED FOR:</b> 2018	<b>INSPECTION DATE:</b> 8-20-15
<b>PAVEMENT TYPE:</b> AC -	<b>FEATURE'S HIGH PCI:</b> 69
<b>FEATURE AREA:</b> 2,862	<b>FEATURE'S LOW PCI:</b> 69
<b>INSPECTED AREA:</b> 2,862	<b>AVERAGE PCI:</b> 69 FAIR
<b>MINIMUM SERVICE LEVEL:</b> 50	<b>ESTIMATED PCI IS:</b> 50 in 2018

## COMMENTS/HISTORY FOR FEATURE 505, TAXILANE

2011 AC  
\*  
\*  
\*

## DISTRESS QUANTITIES FOR FEATURE 505

DISTRESS TYPE	SEVERITY	MEASURED QUANTITY	ESTIMATED TOTAL QUANTITY	UNITS	PERCENTAGE OF All DISTRESS
DEPRESSION	MED	58	58	S.F.	51.4
DEPRESSION	LOW	58	58	S.F.	26.9
LONG.& TRANS. CRACK	LOW	85	85	L.F.	21.5

## BASIC DISTRESS CAUSES

APPROXIMATE AMOUNT OF DISTRESS RELATED TO LOAD ON THE PAVEMENT IS:	0 %
APPROXIMATE AMOUNT OF DISTRESS RELATED TO MATERIALS PROBLEMS IN THE FEATURE IS:	93 %
APPROXIMATE AMOUNT OF DISTRESS RELATED TO AGE OF PAVEMENT AND TRAFFIC REPETITIONS IS:	7 %



AIRPORT: SULLIVAN COUNTY

AIRPAV FEATURE ANALYSIS PROGRAM OUTPUT

FEATURE: 505

DESCRIPTION: TAXILANE

ANALYSIS YEAR: 2015 OPTIMIZED FOR: 2018

INSPECTION DATE: 8-20-15

PAVEMENT TYPE: AC -

AVERAGE PCI AT INSPECTION: 69 FAIR

CONSTRUCTION YEAR: 2011

ESTIMATED PCI IS: 50 in 2018

MINIMUM SERVICE LEVEL: 50

NORMAL PCI FOR THIS AGE: 68

THE FOLLOWING PROJECTS HAVE BEEN SELECTED AS VIABLE ALTERNATIVES

LEGEND	DESCRIPTION	COST	LIFE EXTENSION
▲	RECONSTRUCTION	\$15,340	27 YEARS
▼	STRUCTURAL OVERLAY	\$5,294	25 YEARS
●	NO ACTION	N/A	N/A
-	MINIMUM SERVICE LEVEL, CURRENTLY 50		

PROJECTED PERFORMANCE

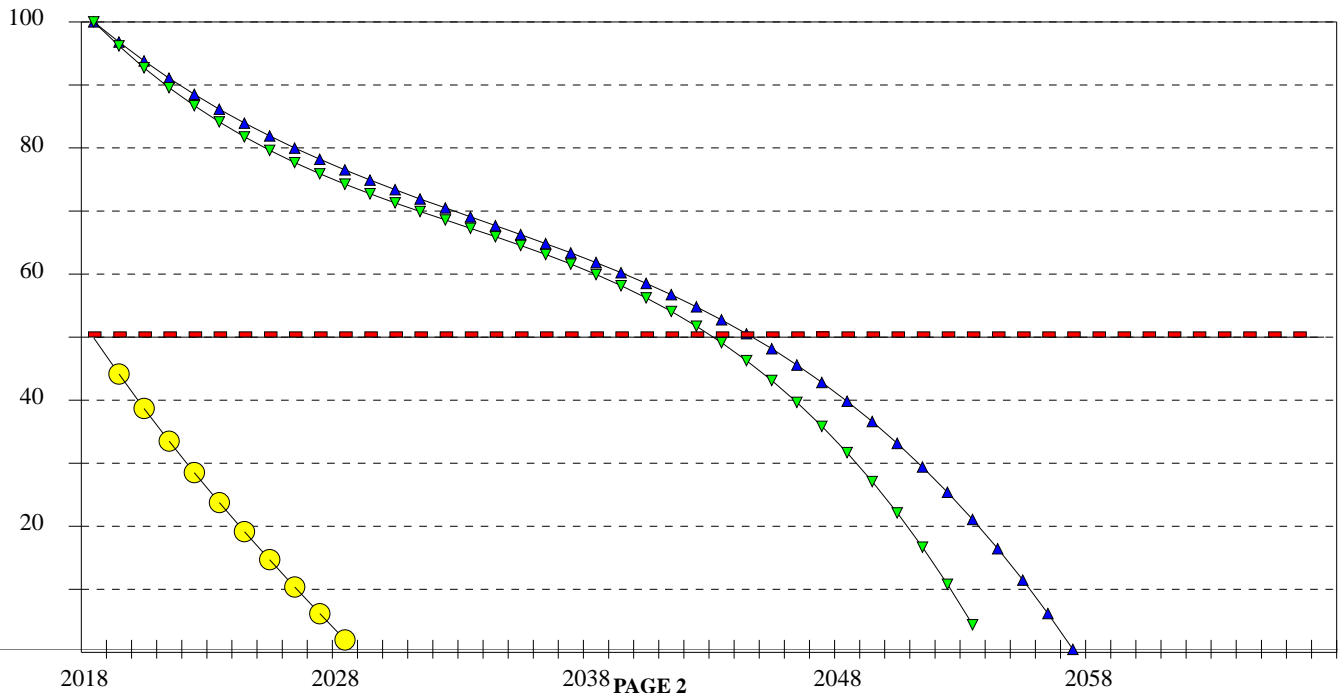

## AIRPORT: SULLIVAN COUNTY

## AIRPAV FEATURE ANALYSIS PROGRAM OUTPUT

FEATURE: 3001

DESCRIPTION: RAMP

ANALYSIS YEAR: 2015

INSPECTION DATE: 8-20-15

PAVEMENT TYPE: AC

FEATURE'S HIGH PCI: 82

FEATURE AREA: 42,800

FEATURE'S LOW PCI: 75

INSPECTED AREA: 20,000

AVERAGE PCI: 78 SATISFACTORY

MINIMUM SERVICE LEVEL: 50

ESTIMATED PCI IS: 78 in 2015

## COMMENTS/HISTORY FOR FEATURE 3001, RAMP

2004: 1.5" p401 / 1.5" p401 / p603 / 2.5"-4.5" RECYCLED AC  
 UNKNOWN EMULSION SEAL  
 1975: 2.5" P401  
 1966: 2 INCH P401 / 6 INCH P208 / 5 INCH P154

## DISTRESS QUANTITIES FOR FEATURE 3001

DISTRESS TYPE	SEVERITY	MEASURED QUANTITY	ESTIMATED TOTAL QUANTITY	UNITS	PERCENTAGE OF All DISTRESS
LONG.& TRANS. CRACK	MED	33	70	L.F.	13.8
LONG.& TRANS. CRACK	LOW	1,514	3,239	L.F.	86.1

## BASIC DISTRESS CAUSES

APPROXIMATE AMOUNT OF DISTRESS RELATED TO LOAD ON THE PAVEMENT IS: 0 %  
 APPROXIMATE AMOUNT OF DISTRESS RELATED TO MATERIALS PROBLEMS IN THE FEATURE IS: 67 %  
 APPROXIMATE AMOUNT OF DISTRESS RELATED TO AGE OF PAVEMENT AND TRAFFIC REPETITIONS IS: 33 %





AIRPORT: SULLIVAN COUNTY

AIRPAV FEATURE ANALYSIS PROGRAM OUTPUT

FEATURE: 3001

DESCRIPTION: RAMP

ANALYSIS YEAR: 2015

INSPECTION DATE: 8-20-15

PAVEMENT TYPE: AC

AVERAGE PCI AT INSPECTION: 78 SATISFACTORY

CONSTRUCTION YEAR: 2004

ESTIMATED PCI IS: 78 in 2015

MINIMUM SERVICE LEVEL: 50

NORMAL PCI FOR THIS AGE: 74

THE FOLLOWING PROJECTS HAVE BEEN SELECTED AS VIABLE ALTERNATIVES

LEGEND	DESCRIPTION	COST	LIFE EXTENSION
●	NO ACTION	N/A	N/A
-	MINIMUM SERVICE LEVEL, CURRENTLY 50		

PROJECTED PERFORMANCE

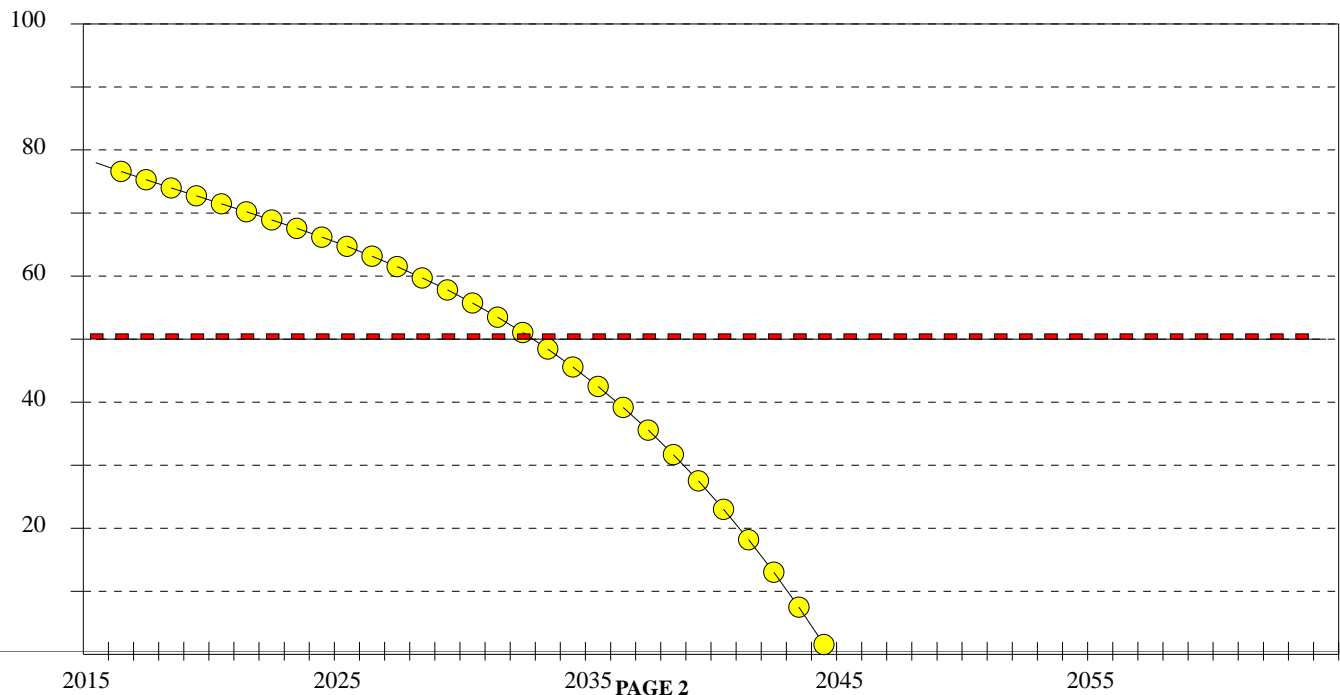

## AIRPORT: SULLIVAN COUNTY

## AIRPAV FEATURE ANALYSIS PROGRAM OUTPUT

FEATURE: 3005

DESCRIPTION: RAMP

ANALYSIS YEAR: 2015

INSPECTION DATE: 8-20-15

PAVEMENT TYPE: AC

FEATURE'S HIGH PCI: 77

FEATURE AREA: 43,950

FEATURE'S LOW PCI: 69

INSPECTED AREA: 17,000

AVERAGE PCI: 73 SATISFACTORY

MINIMUM SERVICE LEVEL: 50

ESTIMATED PCI IS: 73 in 2015

## COMMENTS/HISTORY FOR FEATURE 3005, RAMP

2004: 1.5" p401 / 1.5" p401 / p603 / 9" p209 / 16" TSP-10 LTS  
 UNKNOWN EMULSION SEAL  
 1975: 2.5" P401  
 1966: 2" P401 / 6" P208 / 5" P154

## DISTRESS QUANTITIES FOR FEATURE 3005

DISTRESS TYPE	SEVERITY	MEASURED QUANTITY	ESTIMATED TOTAL QUANTITY	UNITS	PERCENTAGE OF All DISTRESS
DEPRESSION	LOW	40	103	S.F.	4.8
LONG.& TRANS. CRACK	MED	33	85	L.F.	17.1
LONG.& TRANS. CRACK	LOW	1,043	2,696	L.F.	54.9
PATCH & UTILITY CUT	LOW	125	323	S.F.	6.4
RAVELING	LOW	50	129	S.F.	2.7
SWELL	MED	4	10	S.F.	8.4
SWELL	LOW	1	2	S.F.	1.2
WEATHERING	LOW	1,600	4,136	S.F.	4

## BASIC DISTRESS CAUSES

APPROXIMATE AMOUNT OF DISTRESS RELATED TO LOAD ON THE PAVEMENT IS: 4 %  
 APPROXIMATE AMOUNT OF DISTRESS RELATED TO MATERIALS PROBLEMS IN THE FEATURE IS: 67 %  
 APPROXIMATE AMOUNT OF DISTRESS RELATED TO AGE OF PAVEMENT AND TRAFFIC REPETITIONS IS: 29 %



AIRPORT: SULLIVAN COUNTY

AIRPAV FEATURE ANALYSIS PROGRAM OUTPUT

FEATURE: 3005

DESCRIPTION: RAMP

ANALYSIS YEAR: 2015

INSPECTION DATE: 8-20-15

PAVEMENT TYPE: AC

AVERAGE PCI AT INSPECTION: 73 SATISFACTORY

CONSTRUCTION YEAR: 2004

ESTIMATED PCI IS: 73 in 2015

MINIMUM SERVICE LEVEL: 50

NORMAL PCI FOR THIS AGE: 74

THE FOLLOWING PROJECTS HAVE BEEN SELECTED AS VIABLE ALTERNATIVES

LEGEND	DESCRIPTION	COST	LIFE EXTENSION
●	NO ACTION	N/A	N/A
-	MINIMUM SERVICE LEVEL, CURRENTLY 50		

PROJECTED PERFORMANCE

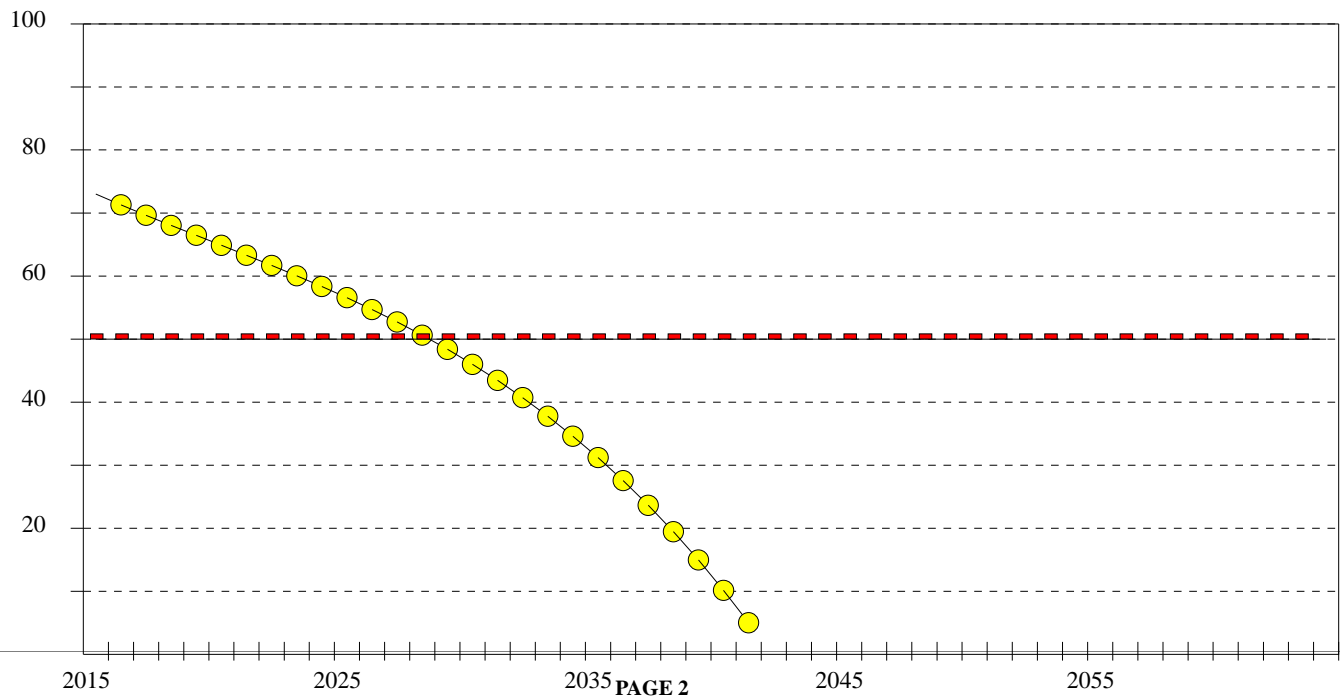

## AIRPORT: SULLIVAN COUNTY

## AIRPAV FEATURE ANALYSIS PROGRAM OUTPUT

<b>FEATURE:</b> 3010	<b>DESCRIPTION:</b> RAMP TAXIWAY
<b>ANALYSIS YEAR:</b> 2015	<b>INSPECTION DATE:</b> 8-20-15
<b>PAVEMENT TYPE:</b> AC OVERLAY	<b>FEATURE'S HIGH PCI:</b> 72
<b>FEATURE AREA:</b> 15,884	<b>FEATURE'S LOW PCI:</b> 69
<b>INSPECTED AREA:</b> 10,500	<b>AVERAGE PCI:</b> 70 FAIR
<b>MINIMUM SERVICE LEVEL:</b> 50	<b>ESTIMATED PCI IS:</b> 70 in 2015

## COMMENTS/HISTORY FOR FEATURE 3010, RAMP TAXIWAY

2004: 1.5" p401 / p603 / EXISTING  
 UNKNOWN EMULSION SEAL  
 1975: 2.5" P401  
 1966: 2" P401 / 6" P208 / 5" P154

## DISTRESS QUANTITIES FOR FEATURE 3010

DISTRESS TYPE	SEVERITY	MEASURED QUANTITY	ESTIMATED TOTAL QUANTITY	UNITS	PERCENTAGE OF All DISTRESS
LONG.& TRANS. CRACK	MED	13	19	L.F.	6.8
LONG.& TRANS. CRACK	LOW	1,148	1,736	L.F.	75.9
SWELL	MED	4	6	S.F.	10.5
SWELL	LOW	10	15	S.F.	1.3
WEATHERING	LOW	1,800	2,723	S.F.	5.3

## BASIC DISTRESS CAUSES

APPROXIMATE AMOUNT OF DISTRESS RELATED TO LOAD ON THE PAVEMENT IS:	0 %
APPROXIMATE AMOUNT OF DISTRESS RELATED TO MATERIALS PROBLEMS IN THE FEATURE IS:	69 %
APPROXIMATE AMOUNT OF DISTRESS RELATED TO AGE OF PAVEMENT AND TRAFFIC REPETITIONS IS:	31 %



AIRPORT: SULLIVAN COUNTY

AIRPAV FEATURE ANALYSIS PROGRAM OUTPUT

FEATURE: 3010

DESCRIPTION: RAMP TAXIWAY

ANALYSIS YEAR: 2015

INSPECTION DATE: 8-20-15

PAVEMENT TYPE: AC OVERLAY

AVERAGE PCI AT INSPECTION: 70 FAIR

CONSTRUCTION YEAR: 2004

ESTIMATED PCI IS: 70 in 2015

MINIMUM SERVICE LEVEL: 50

NORMAL PCI FOR THIS AGE: 72

THE FOLLOWING PROJECTS HAVE BEEN SELECTED AS VIABLE ALTERNATIVES

LEGEND	DESCRIPTION	COST	LIFE EXTENSION
●	NO ACTION	N/A	N/A
-	MINIMUM SERVICE LEVEL, CURRENTLY 50		

PROJECTED PERFORMANCE

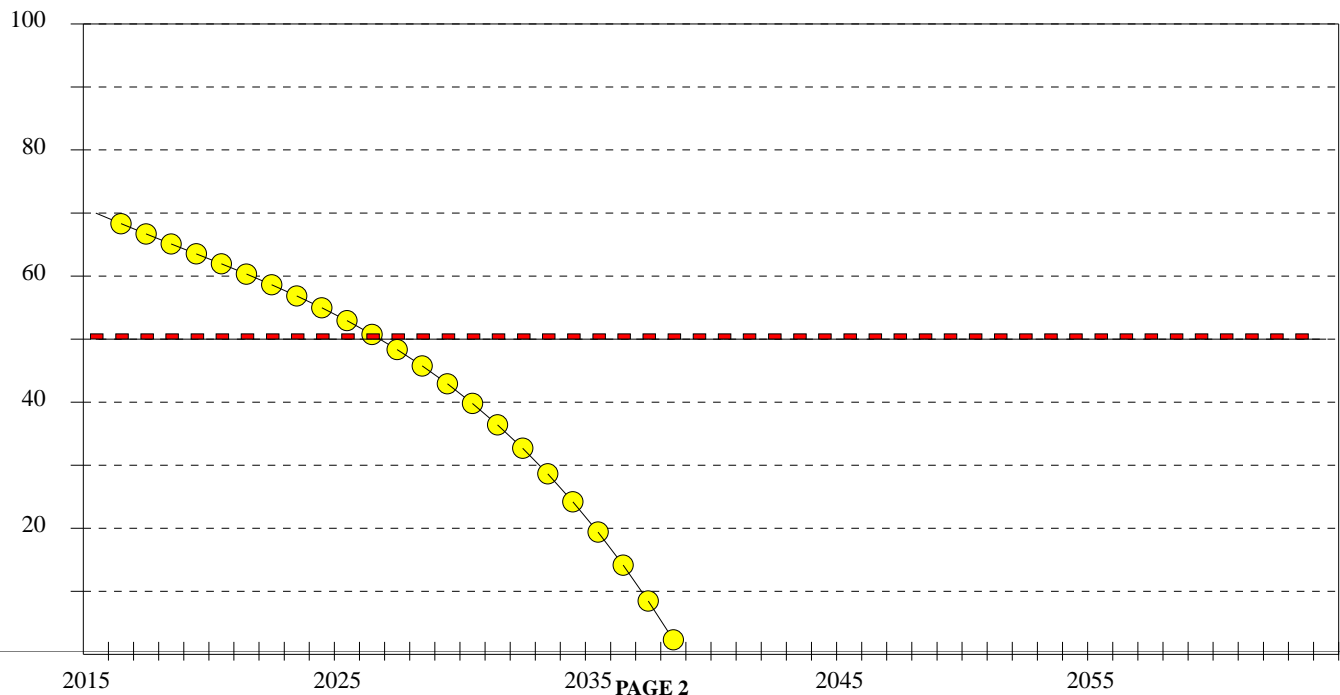

## AIRPORT: SULLIVAN COUNTY

## AIRPAV FEATURE ANALYSIS PROGRAM OUTPUT

FEATURE: 3015

DESCRIPTION: RAMP

ANALYSIS YEAR: 2015

INSPECTION DATE: 8-20-15

PAVEMENT TYPE: AC

FEATURE'S HIGH PCI: 76

FEATURE AREA: 41,000

FEATURE'S LOW PCI: 64

INSPECTED AREA: 20,000

AVERAGE PCI: 72 SATISFACTORY

MINIMUM SERVICE LEVEL: 50

ESTIMATED PCI IS: 72 in 2015

## COMMENTS/HISTORY FOR FEATURE 3015, RAMP

2000 AC Pavement est (Unknown Section)

\*  
\*  
\*

## DISTRESS QUANTITIES FOR FEATURE 3015

DISTRESS TYPE	SEVERITY	MEASURED QUANTITY	ESTIMATED TOTAL QUANTITY	UNITS	PERCENTAGE OF All DISTRESS
LONG.& TRANS. CRACK	MED	407	834	L.F.	36.2
LONG.& TRANS. CRACK	LOW	1,573	3,224	L.F.	50.7
RAVELING	HIGH	5	10	S.F.	4.5
RAVELING	MED	35	71	S.F.	8.4

## BASIC DISTRESS CAUSES

APPROXIMATE AMOUNT OF DISTRESS RELATED TO LOAD ON THE PAVEMENT IS:	0 %
APPROXIMATE AMOUNT OF DISTRESS RELATED TO MATERIALS PROBLEMS IN THE FEATURE IS:	62 %
APPROXIMATE AMOUNT OF DISTRESS RELATED TO AGE OF PAVEMENT AND TRAFFIC REPETITIONS IS:	38 %



AIRPORT: SULLIVAN COUNTY

AIRPAV FEATURE ANALYSIS PROGRAM OUTPUT

FEATURE: 3015

DESCRIPTION: RAMP

ANALYSIS YEAR: 2015

INSPECTION DATE: 8-20-15

PAVEMENT TYPE: AC

AVERAGE PCI AT INSPECTION: 72 SATISFACTORY

CONSTRUCTION YEAR: 2000

ESTIMATED PCI IS: 72 in 2015

MINIMUM SERVICE LEVEL: 50

NORMAL PCI FOR THIS AGE: 69

THE FOLLOWING PROJECTS HAVE BEEN SELECTED AS VIABLE ALTERNATIVES

LEGEND	DESCRIPTION	COST	LIFE EXTENSION
●	NO ACTION	N/A	N/A
-	MINIMUM SERVICE LEVEL, CURRENTLY 50		

PROJECTED PERFORMANCE

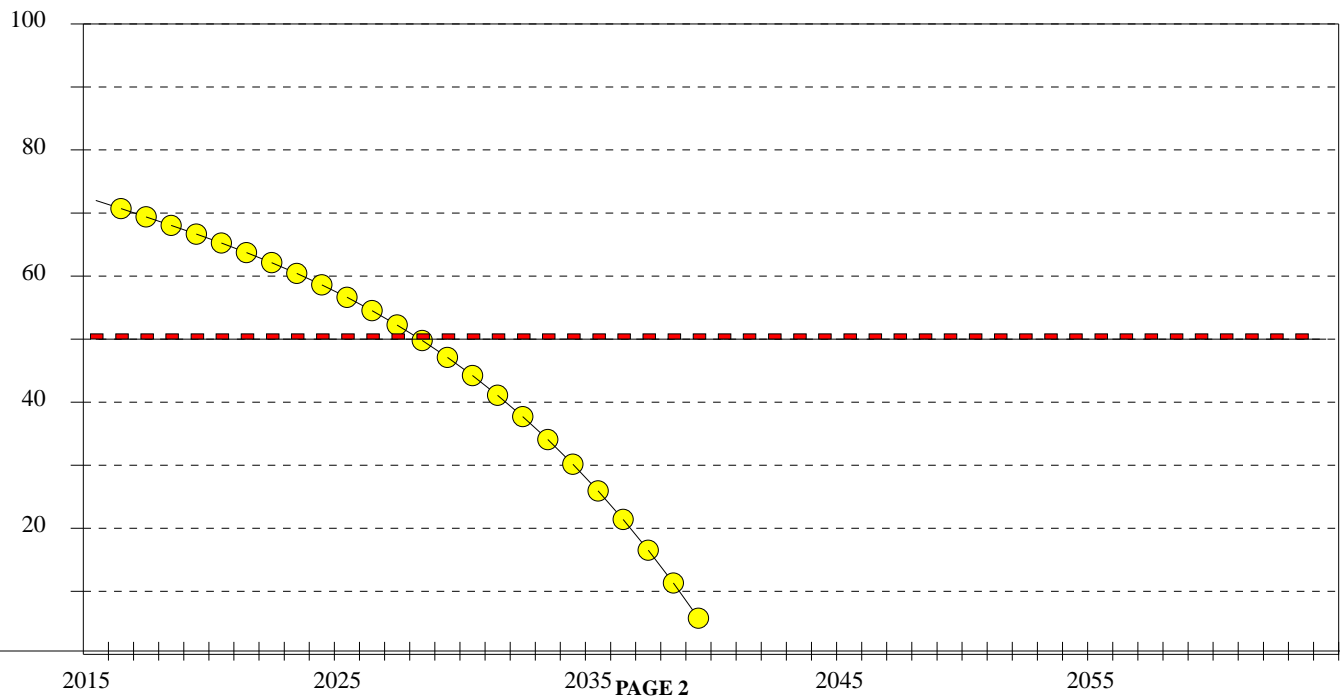

## AIRPORT: SULLIVAN COUNTY

## AIRPAV FEATURE ANALYSIS PROGRAM OUTPUT

<b>FEATURE:</b> 3020	<b>DESCRIPTION:</b> RAMP
<b>ANALYSIS YEAR:</b> 2015	<b>INSPECTION DATE:</b> 8-20-15
<b>PAVEMENT TYPE:</b> AC +	<b>FEATURE'S HIGH PCI:</b> 100
<b>FEATURE AREA:</b> 33,050	<b>FEATURE'S LOW PCI:</b> 100
<b>INSPECTED AREA:</b> 11,410	<b>AVERAGE PCI:</b> 100 GOOD
<b>MINIMUM SERVICE LEVEL:</b> 50	<b>ESTIMATED PCI IS:</b> 96 in 2015

## COMMENTS/HISTORY FOR FEATURE 3020, RAMP

2012 AC  
\*  
\*  
\*

## DISTRESS QUANTITIES FOR FEATURE 3020

DISTRESS TYPE	SEVERITY	MEASURED QUANTITY	ESTIMATED TOTAL QUANTITY	UNITS	PERCENTAGE OF All DISTRESS
---------------	----------	-------------------	--------------------------	-------	----------------------------

## BASIC DISTRESS CAUSES

APPROXIMATE AMOUNT OF DISTRESS RELATED TO LOAD ON THE PAVEMENT IS:	0 %
APPROXIMATE AMOUNT OF DISTRESS RELATED TO MATERIALS PROBLEMS IN THE FEATURE IS:	0 %
APPROXIMATE AMOUNT OF DISTRESS RELATED TO AGE OF PAVEMENT AND TRAFFIC REPETITIONS IS:	0 %





AIRPORT: SULLIVAN COUNTY

AIRPAV FEATURE ANALYSIS PROGRAM OUTPUT

FEATURE: 3020

DESCRIPTION: RAMP

ANALYSIS YEAR: 2015

INSPECTION DATE: 8-20-15

PAVEMENT TYPE: AC +

AVERAGE PCI AT INSPECTION: 100 GOOD

CONSTRUCTION YEAR: 2012

ESTIMATED PCI IS: 96 in 2015

MINIMUM SERVICE LEVEL: 50

NORMAL PCI FOR THIS AGE: 95

THE FOLLOWING PROJECTS HAVE BEEN SELECTED AS VIABLE ALTERNATIVES

LEGEND	DESCRIPTION	COST	LIFE EXTENSION
●	NO ACTION	N/A	N/A
-	MINIMUM SERVICE LEVEL, CURRENTLY 50		

PROJECTED PERFORMANCE

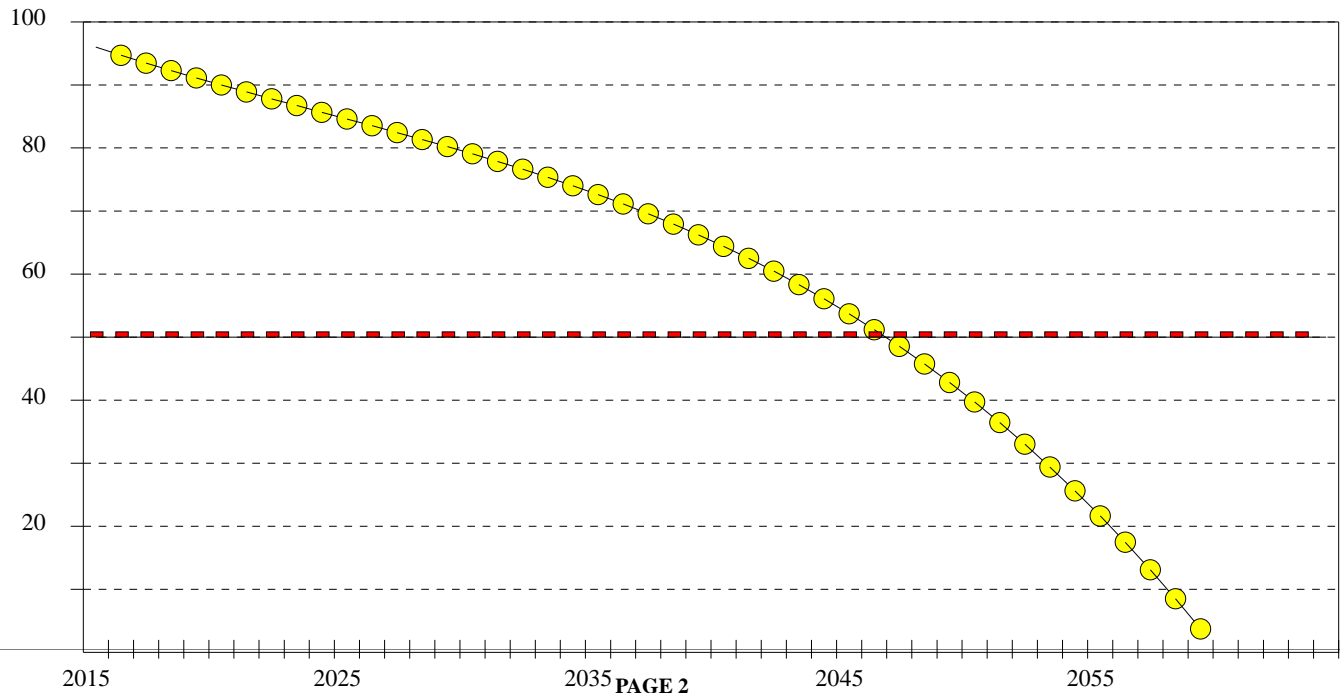

## AIRPORT: SULLIVAN COUNTY

## AIRPAV FEATURE ANALYSIS PROGRAM OUTPUT

FEATURE: 3025

DESCRIPTION: RAMP

ANALYSIS YEAR: 2015

INSPECTION DATE: 8-20-15

PAVEMENT TYPE: AC +

FEATURE'S HIGH PCI: 100

FEATURE AREA: 50,760

FEATURE'S LOW PCI: 94

INSPECTED AREA: 13,500

AVERAGE PCI: 96 GOOD

MINIMUM SERVICE LEVEL: 50

ESTIMATED PCI IS: 94 in 2015

## COMMENTS/HISTORY FOR FEATURE 3025, RAMP

2011 AC/ 12" Lime Treated Base

\*  
\*  
\*

## DISTRESS QUANTITIES FOR FEATURE 3025

DISTRESS TYPE	SEVERITY	MEASURED QUANTITY	ESTIMATED TOTAL QUANTITY	UNITS	PERCENTAGE OF All DISTRESS
LONG.& TRANS. CRACK	LOW	130	488	L.F.	100

## BASIC DISTRESS CAUSES

APPROXIMATE AMOUNT OF DISTRESS RELATED TO LOAD ON THE PAVEMENT IS:	0 %
APPROXIMATE AMOUNT OF DISTRESS RELATED TO MATERIALS PROBLEMS IN THE FEATURE IS:	67 %
APPROXIMATE AMOUNT OF DISTRESS RELATED TO AGE OF PAVEMENT AND TRAFFIC REPETITIONS IS:	33 %



AIRPORT: SULLIVAN COUNTY

AIRPAV FEATURE ANALYSIS PROGRAM OUTPUT

FEATURE: 3025

DESCRIPTION: RAMP

ANALYSIS YEAR: 2015

INSPECTION DATE: 8-20-15

PAVEMENT TYPE: AC +

AVERAGE PCI AT INSPECTION: 96 GOOD

CONSTRUCTION YEAR: 2011

ESTIMATED PCI IS: 94 in 2015

MINIMUM SERVICE LEVEL: 50

NORMAL PCI FOR THIS AGE: 94

THE FOLLOWING PROJECTS HAVE BEEN SELECTED AS VIABLE ALTERNATIVES

LEGEND	DESCRIPTION	COST	LIFE EXTENSION
●	NO ACTION	N/A	N/A
-	MINIMUM SERVICE LEVEL, CURRENTLY 50		

PROJECTED PERFORMANCE

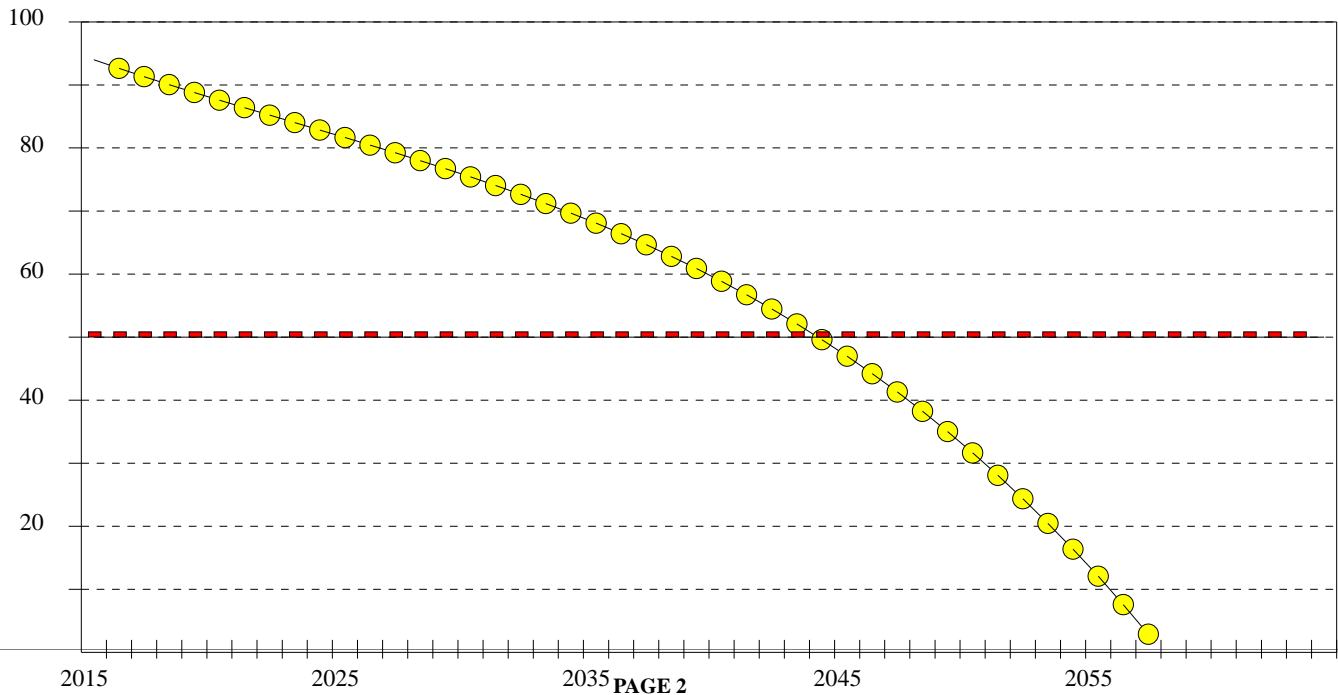

## AIRPORT: SULLIVAN COUNTY

## AIRPAV FEATURE ANALYSIS PROGRAM OUTPUT

<b>FEATURE:</b> 3050	<b>DESCRIPTION:</b> RAMP
<b>ANALYSIS YEAR:</b> 2015	<b>INSPECTION DATE:</b> 8-20-15
<b>PAVEMENT TYPE:</b> PCC	<b>FEATURE'S HIGH PCI:</b> 85
<b>FEATURE AREA:</b> 3,434	<b>FEATURE'S LOW PCI:</b> 85
<b>INSPECTED AREA:</b> 3,300	<b>AVERAGE PCI:</b> 85 SATISFACTORY
<b>MINIMUM SERVICE LEVEL:</b> 50	<b>ESTIMATED PCI IS:</b> 85 in 2015

## COMMENTS/HISTORY FOR FEATURE 3050, RAMP

2000 PCC est

\*  
\*  
\*

## DISTRESS QUANTITIES FOR FEATURE 3050

DISTRESS TYPE	SEVERITY	MEASURED QUANTITY	ESTIMATED TOTAL QUANTITY	UNITS	PERCENTAGE OF All DISTRESS
CORNER BREAK	LOW	3	3	SLABS	49.4
LONG/TRAN/DIAG CRK.	LOW	3	3	SLABS	47
SHRINKAGE CRACKS	N/A	1	1	SLABS	3.5

## BASIC DISTRESS CAUSES

APPROXIMATE AMOUNT OF DISTRESS RELATED TO LOAD ON THE PAVEMENT IS:	49 %
APPROXIMATE AMOUNT OF DISTRESS RELATED TO MATERIALS PROBLEMS IN THE FEATURE IS:	18 %
APPROXIMATE AMOUNT OF DISTRESS RELATED TO AGE OF PAVEMENT AND TRAFFIC REPETITIONS IS:	33 %



AIRPORT: SULLIVAN COUNTY

AIRPAV FEATURE ANALYSIS PROGRAM OUTPUT

FEATURE: 3050

DESCRIPTION: RAMP

ANALYSIS YEAR: 2015

INSPECTION DATE: 8-20-15

PAVEMENT TYPE: PCC

AVERAGE PCI AT INSPECTION: 85 SATISFACTORY

CONSTRUCTION YEAR: 2000

ESTIMATED PCI IS: 85 in 2015

MINIMUM SERVICE LEVEL: 50

NORMAL PCI FOR THIS AGE: 85

THE FOLLOWING PROJECTS HAVE BEEN SELECTED AS VIABLE ALTERNATIVES

LEGEND	DESCRIPTION	COST	LIFE EXTENSION
●	NO ACTION	N/A	N/A
-	MINIMUM SERVICE LEVEL, CURRENTLY 50		

PROJECTED PERFORMANCE

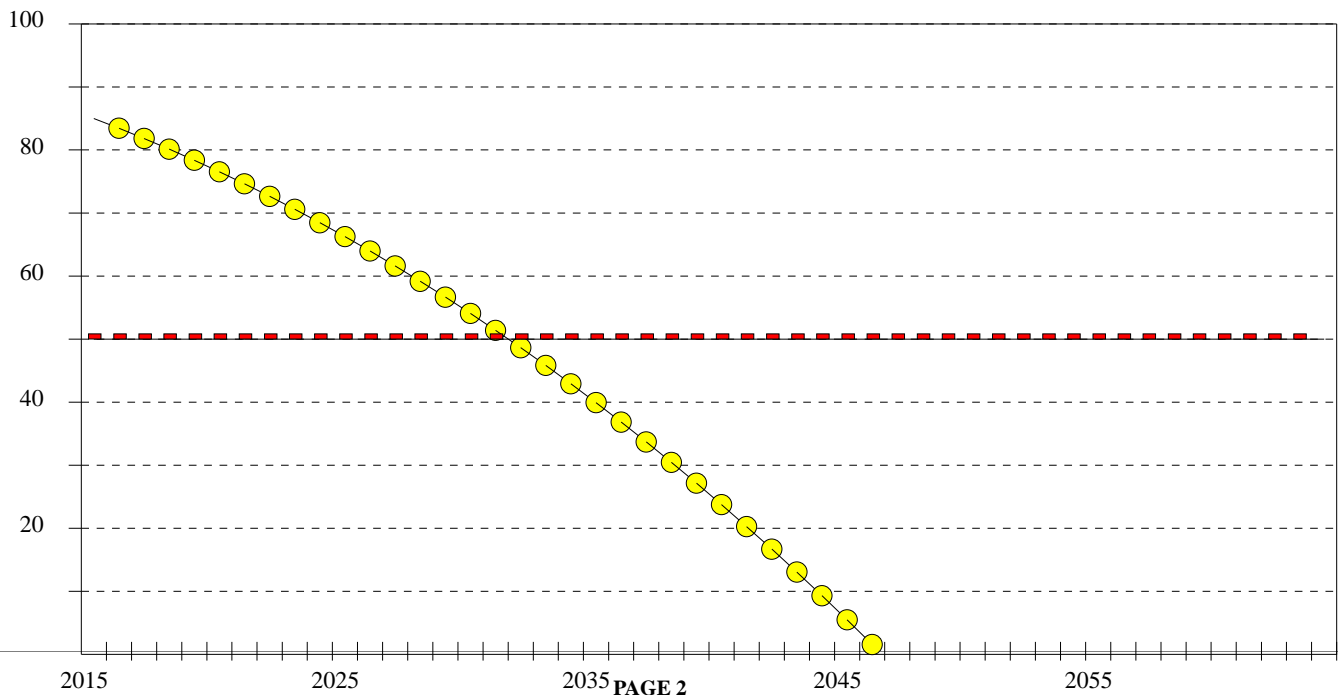

## AIRPORT: SULLIVAN COUNTY

## AIRPAV FEATURE ANALYSIS PROGRAM OUTPUT

<b>FEATURE:</b> 3105	<b>DESCRIPTION:</b> TEES
<b>ANALYSIS YEAR:</b> 2015	<b>INSPECTION DATE:</b> 8-20-15
<b>PAVEMENT TYPE:</b> PCC	<b>FEATURE'S HIGH PCI:</b> 100
<b>FEATURE AREA:</b> 21,688	<b>FEATURE'S LOW PCI:</b> 100
<b>INSPECTED AREA:</b> 10,875	<b>AVERAGE PCI:</b> 100 GOOD
<b>MINIMUM SERVICE LEVEL:</b> 50	<b>ESTIMATED PCI IS:</b> 100 in 2015

## COMMENTS/HISTORY FOR FEATURE 3105, TEES

2009 PCC est

\*  
\*  
\*

## DISTRESS QUANTITIES FOR FEATURE 3105

DISTRESS TYPE	SEVERITY	MEASURED QUANTITY	ESTIMATED TOTAL QUANTITY	UNITS	PERCENTAGE OF All DISTRESS
---------------	----------	----------------------	-----------------------------	-------	-------------------------------

## BASIC DISTRESS CAUSES

APPROXIMATE AMOUNT OF DISTRESS RELATED TO LOAD ON THE PAVEMENT IS:	0 %
APPROXIMATE AMOUNT OF DISTRESS RELATED TO MATERIALS PROBLEMS IN THE FEATURE IS:	0 %
APPROXIMATE AMOUNT OF DISTRESS RELATED TO AGE OF PAVEMENT AND TRAFFIC REPETITIONS IS:	0 %

AIRPORT: SULLIVAN COUNTY

AIRPAV FEATURE ANALYSIS PROGRAM OUTPUT

FEATURE: 3105

DESCRIPTION: TEES

ANALYSIS YEAR: 2015

INSPECTION DATE: 8-20-15

PAVEMENT TYPE: PCC

AVERAGE PCI AT INSPECTION: 100 GOOD

CONSTRUCTION YEAR: 2009

ESTIMATED PCI IS: 100 in 2015

MINIMUM SERVICE LEVEL: 50

NORMAL PCI FOR THIS AGE: 96

THE FOLLOWING PROJECTS HAVE BEEN SELECTED AS VIABLE ALTERNATIVES

LEGEND	DESCRIPTION	COST	LIFE EXTENSION
●	NO ACTION	N/A	N/A
-	MINIMUM SERVICE LEVEL, CURRENTLY 50		

PROJECTED PERFORMANCE

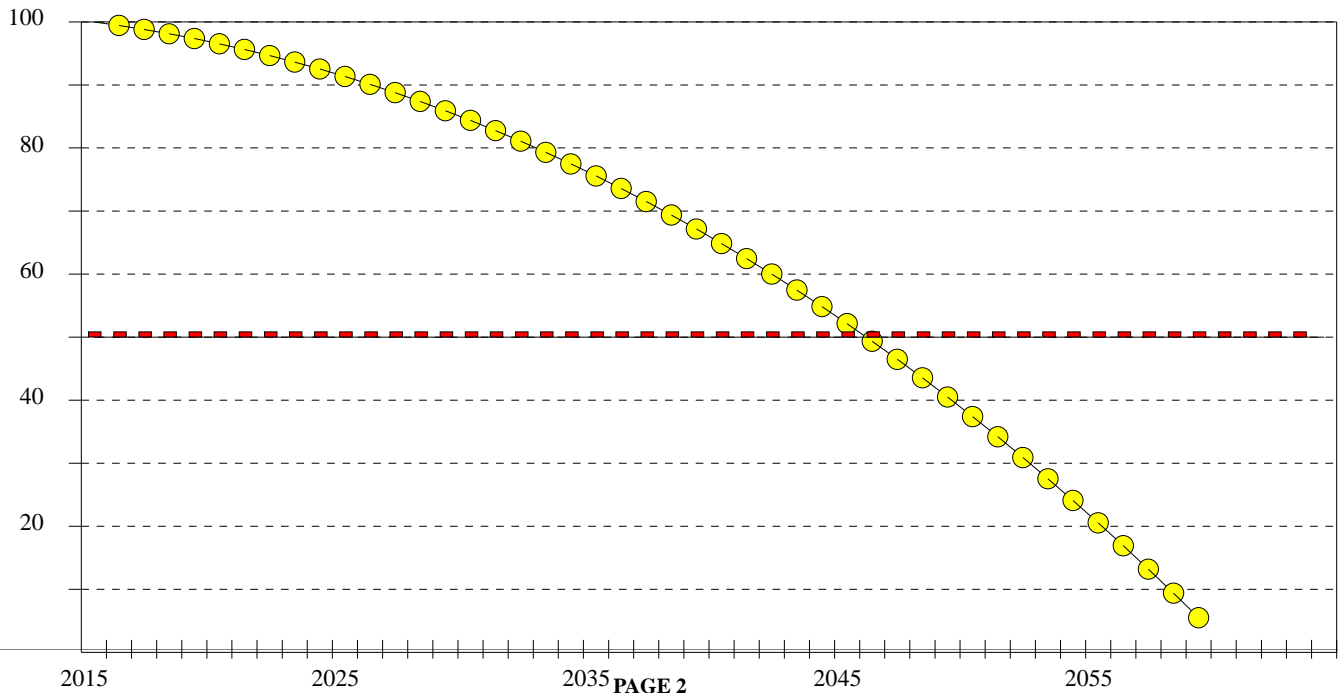

## AIRPORT: SULLIVAN COUNTY

## AIRPAV FEATURE ANALYSIS PROGRAM OUTPUT

<b>FEATURE:</b> 5001	<b>DESCRIPTION:</b> RUNWAY 18-36
<b>ANALYSIS YEAR:</b> 2015	<b>INSPECTION DATE:</b> 8-20-15
<b>PAVEMENT TYPE:</b> AC	<b>FEATURE'S HIGH PCI:</b> 85
<b>FEATURE AREA:</b> 267,000	<b>FEATURE'S LOW PCI:</b> 66
<b>INSPECTED AREA:</b> 48,750	<b>AVERAGE PCI:</b> 79 SATISFACTORY
<b>MINIMUM SERVICE LEVEL:</b> 55	<b>ESTIMATED PCI IS:</b> 79 in 2015

## COMMENTS/HISTORY FOR FEATURE 5001, RUNWAY 18-36

2004: 1.5" p401 / 1.5" p401 / p603 / 2.5"-4.5" RECYCLED AC  
 UNKOWN EMULSION SEAL  
 1975: 2.5" P401  
 1966: 2 INCH P401 / 6 INCH P208 / 5 INCH P154

## DISTRESS QUANTITIES FOR FEATURE 5001

DISTRESS TYPE	SEVERITY	MEASURED QUANTITY	ESTIMATED TOTAL QUANTITY	UNITS	PERCENTAGE OF All DISTRESS
DEPRESSION	HIGH	32	32	S.F.	.2
LONG.& TRANS. CRACK	LOW	3,129	16,827	L.F.	66.8
LONG.& TRANS. CRACK	MED	330	1,837	L.F.	30.2
PATCH & UTILITY CUT	LOW	1,000	1,000	S.F.	.2
SWELL	LOW	15	94	S.F.	.5

## BASIC DISTRESS CAUSES

APPROXIMATE AMOUNT OF DISTRESS RELATED TO LOAD ON THE PAVEMENT IS:	0 %
APPROXIMATE AMOUNT OF DISTRESS RELATED TO MATERIALS PROBLEMS IN THE FEATURE IS:	67 %
APPROXIMATE AMOUNT OF DISTRESS RELATED TO AGE OF PAVEMENT AND TRAFFIC REPETITIONS IS:	33 %





AIRPORT: SULLIVAN COUNTY

AIRPAV FEATURE ANALYSIS PROGRAM OUTPUT

FEATURE: 5001

DESCRIPTION: RUNWAY 18-36

ANALYSIS YEAR: 2015

INSPECTION DATE: 8-20-15

PAVEMENT TYPE: AC

AVERAGE PCI AT INSPECTION: 79 SATISFACTORY

CONSTRUCTION YEAR: 2004

ESTIMATED PCI IS: 79 in 2015

MINIMUM SERVICE LEVEL: 55

NORMAL PCI FOR THIS AGE: 74

THE FOLLOWING PROJECTS HAVE BEEN SELECTED AS VIABLE ALTERNATIVES

LEGEND	DESCRIPTION	COST	LIFE EXTENSION
●	NO ACTION	N/A	N/A
-	MINIMUM SERVICE LEVEL, CURRENTLY 55		

PROJECTED PERFORMANCE

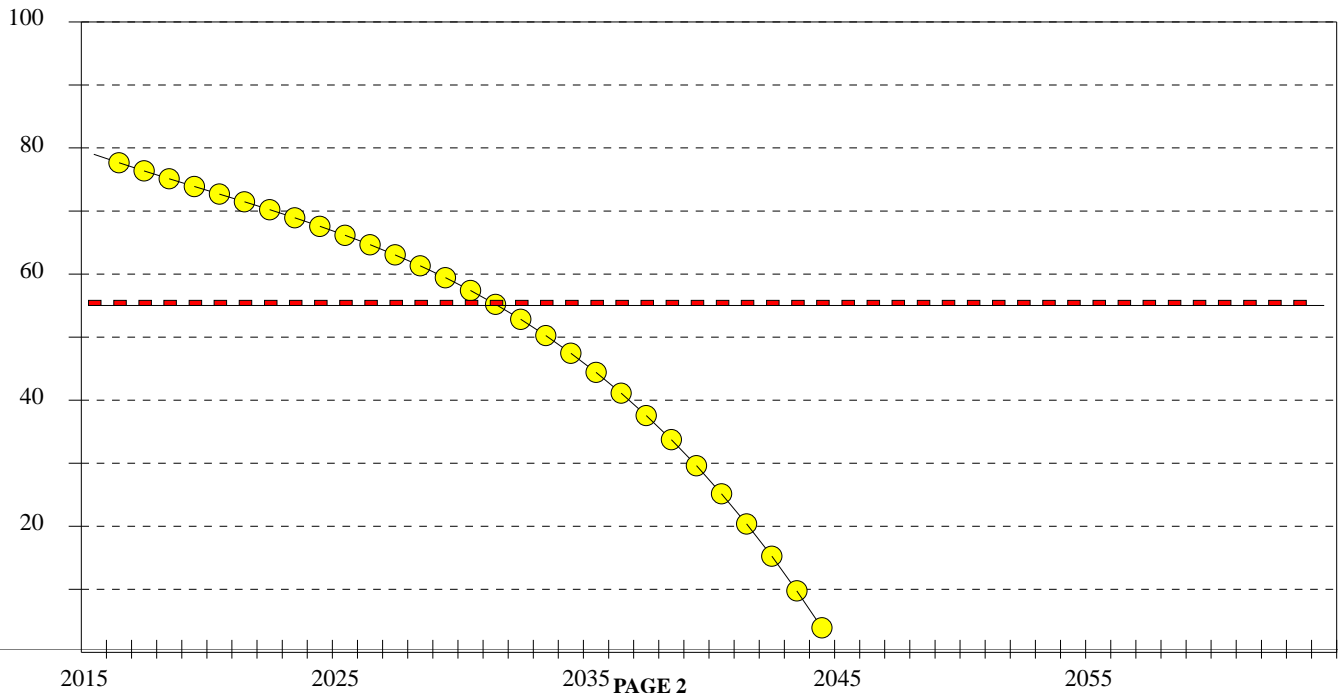

## AIRPORT: SULLIVAN COUNTY

## AIRPAV FEATURE ANALYSIS PROGRAM OUTPUT

FEATURE: 5010

DESCRIPTION: RUNWAY 18-36

ANALYSIS YEAR: 2015

INSPECTION DATE: 8-20-15

PAVEMENT TYPE: AC

FEATURE'S HIGH PCI: 86

FEATURE AREA: 60,000

FEATURE'S LOW PCI: 73

INSPECTED AREA: 22,500

AVERAGE PCI: 80 SATISFACTORY

MINIMUM SERVICE LEVEL: 55

ESTIMATED PCI IS: 80 in 2015

## COMMENTS/HISTORY FOR FEATURE 5010, RUNWAY 18-36

2000 AC Pavement est (Unknown Section)

\*  
\*  
\*

## DISTRESS QUANTITIES FOR FEATURE 5010

DISTRESS TYPE	SEVERITY	MEASURED QUANTITY	ESTIMATED TOTAL QUANTITY	UNITS	PERCENTAGE OF All DISTRESS
DEPRESSION	LOW	3	8	S.F.	0
LONG.& TRANS. CRACK	MED	144	384	L.F.	34.6
LONG.& TRANS. CRACK	LOW	768	2,048	L.F.	43.3
PATCH & UTILITY CUT	LOW	95	253	S.F.	9.4
SWELL	MED	35	93	S.F.	10.2
WEATHERING	MED	190	506	S.F.	1.8
WEATHERING	LOW	200	533	S.F.	.5

## BASIC DISTRESS CAUSES

APPROXIMATE AMOUNT OF DISTRESS RELATED TO LOAD ON THE PAVEMENT IS:	6 %
APPROXIMATE AMOUNT OF DISTRESS RELATED TO MATERIALS PROBLEMS IN THE FEATURE IS:	66 %
APPROXIMATE AMOUNT OF DISTRESS RELATED TO AGE OF PAVEMENT AND TRAFFIC REPETITIONS IS:	28 %



AIRPORT: SULLIVAN COUNTY

AIRPAV FEATURE ANALYSIS PROGRAM OUTPUT

FEATURE: 5010

DESCRIPTION: RUNWAY 18-36

ANALYSIS YEAR: 2015

INSPECTION DATE: 8-20-15

PAVEMENT TYPE: AC

AVERAGE PCI AT INSPECTION: 80 SATISFACTORY

CONSTRUCTION YEAR: 2000

ESTIMATED PCI IS: 80 in 2015

MINIMUM SERVICE LEVEL: 55

NORMAL PCI FOR THIS AGE: 69

THE FOLLOWING PROJECTS HAVE BEEN SELECTED AS VIABLE ALTERNATIVES

LEGEND	DESCRIPTION	COST	LIFE EXTENSION
●	NO ACTION	N/A	N/A
-	MINIMUM SERVICE LEVEL, CURRENTLY 55		

PROJECTED PERFORMANCE

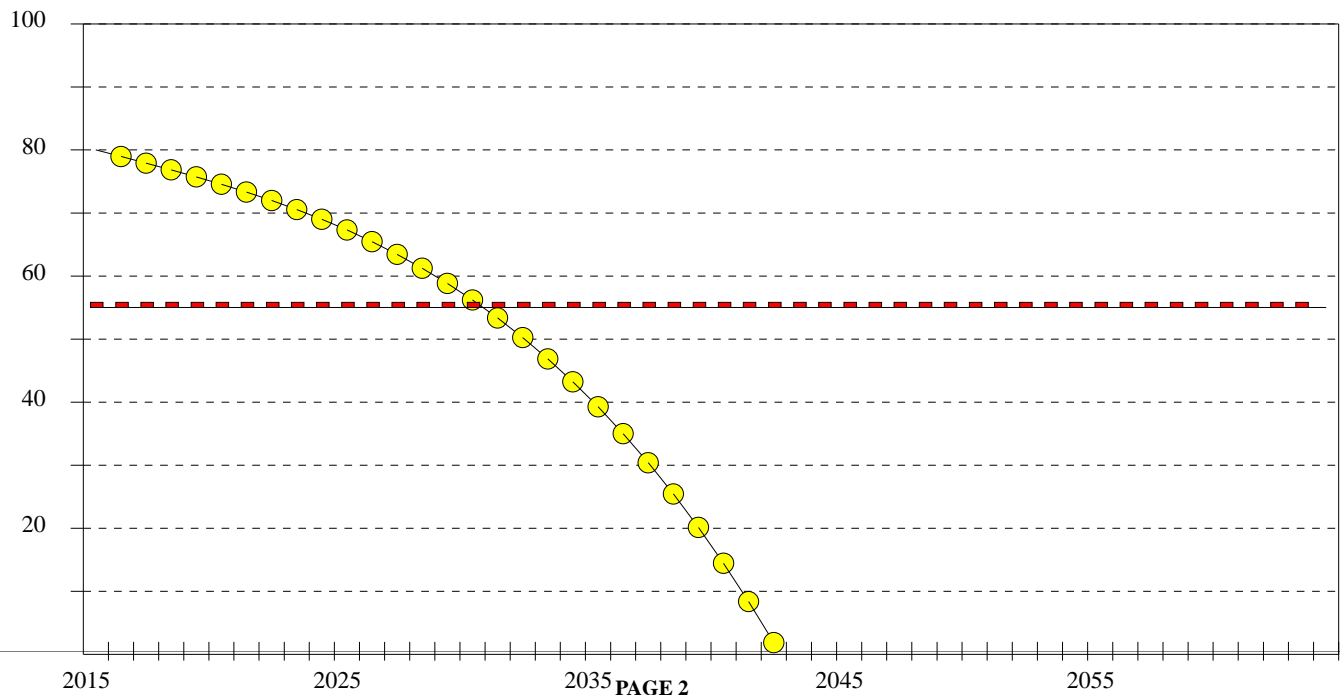

This page intentionally left blank

## Appendix F. Airport Responsibilities

### Grant Assurances

In 1995, Congress mandated that the FAA require, as a condition of grant funding, that airport sponsors prepare documentation of a maintenance management program on pavement that has been constructed, reconstructed, or repaired with Federal assistance.

This report fulfills many of the grant assurance requirements, including documenting:

- Locating all runways, taxiways, and aprons.
- Documenting pavement dimensions.
- Documenting types of pavement.
- Documenting year of construction or most recent major rehabilitation.

The airport owners must be an active participant in maintaining compliance. Actions taken to ensure compliance include:

- Annotating areas constructed or repaired with Federal aid.
- Conducting monthly drive-by inspections to detect changes in pavement condition.
- Recording each drive-by inspection and any maintenance performed as a result.
- Keeping complete records of all maintenance activities.
- Keeping records for 5 years.
- Documenting detailed inspection information with a history of recorded pavement deterioration by PCI survey (e.g., this report).

ASSURANCES Airport Sponsors	
<b>A. General.</b>	<ol style="list-style-type: none"> <li>1. These assurances shall be complied with in the performance of grant agreements for airport development, airport planning, and noise compatibility program grants for airport sponsors.</li> <li>2. These assurances are required to be submitted as part of the project application by sponsors requesting funds under the provisions of Title 49, U.S.C., subtitle VII, as amended. As used herein, the term "public agency sponsor" means a public agency with control of a public-use airport; the term "private sponsor" means a private owner of a public-use airport; and the term "sponsor" includes both public agency sponsors and private sponsors.</li> <li>3. Upon acceptance of the grant offer by the sponsor, these assurances are incorporated in and become part of the grant agreement.</li> </ol>
<b>B. Duration and Applicability.</b>	<ol style="list-style-type: none"> <li>1. <b>Airport development or Noise Compatibility Program Projects Undertaken by a Public Agency Sponsor.</b> The terms, conditions and assurances of the grant agreement shall remain in full force and effect throughout the useful life of the facilities developed or equipment acquired for an airport development or noise compatibility program project, or throughout the useful life of the project items installed within a facility under a noise compatibility program project, but in any event not to exceed twenty (20) years from the date of acceptance of a grant offer of Federal funds for the project. However, there shall be no limit on the duration of the assurances regarding Exclusive Rights and Airport Revenue so long as the airport is used as an airport. There shall be no limit on the duration of the terms, conditions, and assurances with respect to real property acquired with federal funds. Furthermore, the duration of the Civil Rights assurance shall be specified in the assurances.</li> <li>2. <b>Airport Development or Noise Compatibility Projects Undertaken by a Private Sponsor.</b> The preceding paragraph 1 also applies to a private sponsor except that the useful life of project items installed within a facility or the useful life of the facilities developed or equipment acquired under an airport development or noise compatibility program project shall be no less than ten (10) years from the date of acceptance of Federal aid for the project.</li> <li>3. <b>Airport Planning Undertaken by a Sponsor.</b> Unless otherwise specified in the grant agreement, only Assurances 1, 2, 3, 5, 6, 13, 18, 30, 32, 33, and 34 in section C apply to planning projects. The terms, conditions, and assurances of the grant agreement shall remain in full force and effect during the life of the project.</li> </ol>
<b>C. Sponsor Certification.</b>	<p>The sponsor hereby assures and certifies, with respect to this grant that:</p> <ol style="list-style-type: none"> <li>1. <b>General Federal Requirements.</b> It will comply with all applicable Federal laws, regulations, executive orders, policies, guidelines, and requirements as they relate to the application, acceptance and use of Federal funds for this project including but not limited to the following: <ul style="list-style-type: none"> <li><b>Federal Legislation</b> <ol style="list-style-type: none"> <li>a. Title 49, U.S.C., subtitle VII, as amended.</li> <li>b. Davis-Bacon Act - 40 U.S.C. 276(a), <i>et seq.</i><sup>1</sup></li> <li>c. Federal Fair Labor Standards Act - 29 U.S.C. 201, <i>et seq.</i></li> <li>d. Hatch Act - 5 U.S.C. 1501, <i>et seq.</i><sup>2</sup></li> </ol> </li> </ul> </li> </ol>
<hr/> Airport Assurances (3/2005)	

The table on the following pages is available for maintaining a record of drive-by inspections and maintenance repairs.

Table F-1. Monthly Pavement Inspection Log

Date	Inspector	Conditions/Changes	Repairs/Work Order

Date	Inspector	Conditions/Changes	Repairs/Work Order

Date	Inspector	Conditions/Changes	Repairs/Work Order



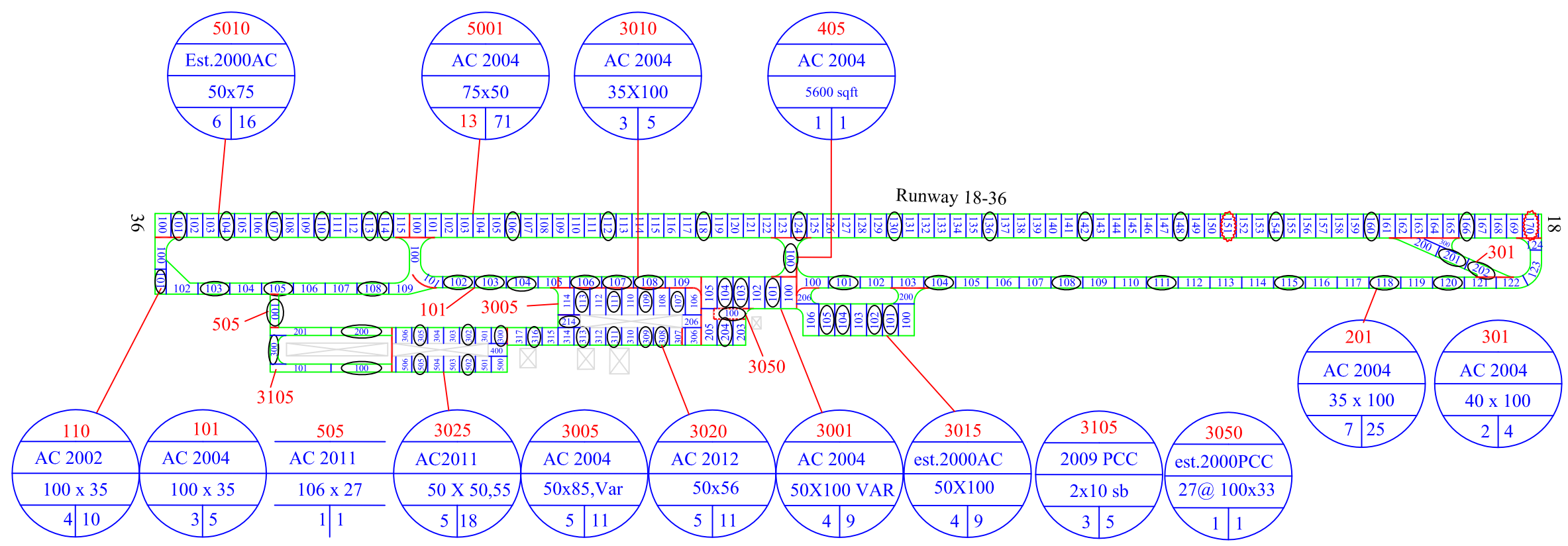

PCI Inspection Map Sullivan County Airport (SIV)			
ENGINEER: BDA	DRAWN BY: JCB	DATE: Jan 2016	CTAF 122.8