

Pavement Condition Report

Indianapolis Downtown Heliport

Project 15805741

Prepared for:

Indiana Department of Transportation
 Office of Aviation
 100 N. Senate Ave.
 Indianapolis, IN 46204



Prepared by:

Applied Research Associates, Inc.
 6314 Odana Rd.
 Madison, WI 53719
 (608) 274-6409



February 2015

Executive Summary

Background

Since 1995, airports have been required to implement a pavement maintenance-management program to receive funding for any project constructed using Federal money. To assist individual airports in meeting this requirement and help improve airport pavement conditions statewide, the Indiana Department of Transportation, Office of Aviation contracted with Applied Research Associates, Inc. to provide pavement evaluation surveys at local airports. This report documents pavement condition at Indianapolis Downtown Heliport in August 2014.

A primary objective of the pavement management program is to determine maintenance and rehabilitation needs by comparing pavement condition to a standardized benchmark called the minimum service level (MSL), defined as the minimum pavement condition acceptable in managing Indiana’s airfield pavements. The benchmark MSL values used to trigger rehabilitation are shown below.

Runway	Taxiway	Apron
60	55	55

Pavement Condition

The average inspected Pavement Condition Index (PCI) for all the airfield pavements was 97.

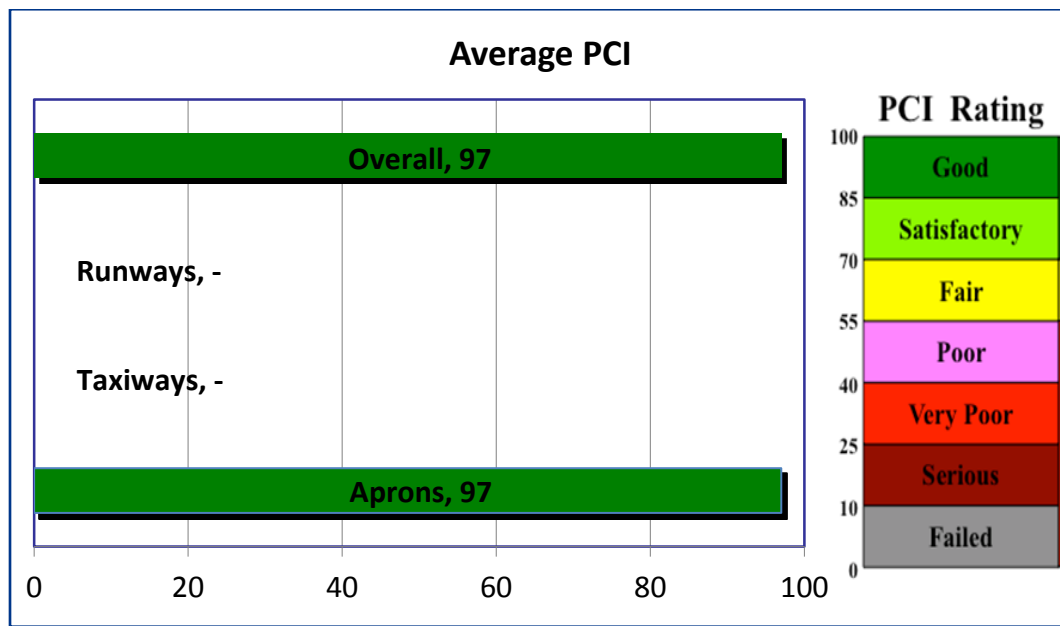

Capital Improvement Program

The table below provides a summary of the projected pavement rehabilitation needs for the next 5 years of the capital improvement program, starting in 2015. The estimated cost for the rehabilitation actions that provide the greatest increase in pavement service life is approximately \$4,100 in 2015 dollars. If no action is taken, the overall PCI is projected to drop from 97 to 87 by 2020.

Project Year	Calendar Year	Amount
Year 1	2015	-
Year 2	2016	-
Year 3	2017	4,121
Year 4	2018	-
Year 5	2019	-
5-Year Total		\$ 4,121

Maintenance

Analysis of potential maintenance projects identified approximately 60 linear feet of crack sealing and crack repair needs, at an estimated total cost of approximately \$50.

Specific recommendations to help prioritize airfield maintenance are found in chapter 4 of this report. A summary of all identified maintenance needs is shown in the table below and in the figure on the following page.

Work Item	Quantity	Unit	Cost
AC SUSTAINING CRACK REPAIR	55	L.F.	48
Total:			\$48

AC = asphalt concrete; PCC = portland cement concrete; S.F. = square feet; L.F. = linear feet

INDIANAPOLIS DOWNTOWN HELIPORT

RECOMMENDED MAINTENANCE

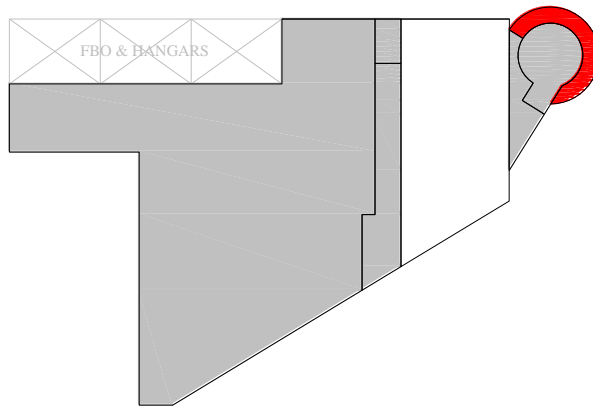

Table of Contents

1. Introduction.....	1
1.1 Objective and Scope	1
1.2 Description of Tasks Performed.....	1
2. Pavement Condition Evaluation	7
2.1 Overview	7
2.2 Distress Types and Frequency	11
2.3 PCI Summary.....	11
2.4 Analysis Commentary	12
3. Capital Improvement Program.....	13
3.1 Analysis	13
3.2 Cost Estimates	13
3.3 Capital Improvement Strategies	17
4. Maintenance Management Program.....	19
4.1 General Comments	19
4.2 Recommended Maintenance Actions.....	19
4.3 Pavement Deterioration	21
4.4 Best Practices.....	24
4.5 Pavement Repair Materials	27
4.6 Pavement Repair Equipment.....	27
Appendix A. AIRPAV Software.....	29
Appendix B. General Maintenance Techniques.....	31
Appendix C. PCI Summary.....	39
Appendix D. Distress Identification	41
Appendix E. Feature Analysis.....	49
Appendix F. Airport Responsibilities.....	63

Table of Figures

Figure 1-1. Pavement Numbering System	3
Figure 1-2. PCI Value and Descriptive Rating	4
Figure 2-1. Inspected Pavement Condition	8
Figure 2-2. Pavement Condition by Branch Use	9
Figure 2-3. Typical Good PCC Pavement (Feature 3015).....	9
Figure 2-4. Typical Fair AC Pavement (Feature 3010)	10
Figure 3-1. Programmed CIP.....	17
Figure 4-1. Recommended Maintenance	20

Table of Tables

Table 1-1. Minimum Service Levels	1
Table 1-2. Inspection Density	3
Table 2-1. Definition and Distribution of PCI Ratings	7
Table 2-2. Distress Frequency in AC Pavement	11
Table 2-3. Distress Frequency in PCC Pavement	11
Table 2-4. PCI Results	11
Table 2-7. Apron Condition Distribution	12
Table 3-1. Unit Costs.....	14
Table 3-2. Most Comprehensive Repair	17
Table 3-3. Lowest Annual Cost Repair	17
Table 3-4. All Viable Options	18
Table 4-1. Recommend Maintenance Actions	19
Table 4-4. Recommend AC Sustaining Crack Repair.....	19
Table 4-3. General Maintenance Policy (AC).....	25
Table 4-4. General Maintenance Policy (PCC)	26

GLOSSARY OF ABBREVIATIONS

AC	- asphalt concrete
ACC	- asphalt overlay on existing asphalt
APC	- asphalt overlay on existing concrete
APMS	- airport pavement management system
ARA	- Applied Research Associates, Inc.
CADD	- computer-aided design and drafting
CIP	- capital improvement program
FAA	- Federal Aviation Administration
FOD	- foreign object damage
GIS	- geographic information system
INDOT	- Indiana Department of Transportation
L&T	- longitudinal and transverse
LTD	- longitudinal, transverse, and diagonal
M&R	- maintenance and rehabilitation
MSL	- minimum service level
PCC	- portland cement concrete
PCI	- Pavement Condition Index
PCN	- Pavement Classification Number
PDF	- portable electronic document

1. Introduction

1.1 Objective and Scope

The Indiana Department of Transportation, Office of Aviation (INDOT) retained Applied Research Associates, Inc., (ARA) to provide airfield pavement inspection, pavement evaluation, and pavement management services for Indiana’s statewide network of airfield pavements. The pavement evaluations documented in this report were performed under purchase order number 15805741.

A primary objective of INDOT’s ongoing pavement evaluation and management program is to determine maintenance and rehabilitation (M&R) needs by comparing the Pavement Condition Index (PCI) to a standardized benchmark called the minimum service level (MSL). The MSL is defined as the minimum pavement condition acceptable in managing INDOT’s airside pavement. The benchmark MSL values used to trigger rehabilitation vary by airport classification and are shown in Table 1-1.

Table 1-1. Minimum Service Levels

Facility	Primary	Commercial Service	Large GA > 3600’Rwy	Small GA < 3600’Rwy
Runway	70	65	60	55
Taxiway	65	60	55	50
Apron	65	60	55	50

Additional goals of this project were to implement a software program to manage the pavement network, develop performance curves based on historical rates of pavement deterioration, forecast future pavement conditions, identify and recommend specific M&R actions to address the root cause of the documented pavement distress, and estimate the cost and ideal timing of the recommend M&R. The following tasks were performed in support of the project goals:

- Review record documents
- Define the pavement network
- Conduct an airfield condition survey
- Update the AIRPAV database & software
- Develop a 5-year airfield M&R work plan
- Report findings to INDOT

1.2 Description of Tasks Performed

1.2.1 Records Review

A detailed records review was performed to determine the airport’s construction history and the as-built cross section for each pavement feature. Plan sets for recent projects were provided to ARA in computer-aided design and drafting (CADD) format. Older plans sets were provided as hard copies or in portable electronic document (PDF) format.

1.2.2 Define Pavement Network

Prior to the field survey, a pavement network map was developed using available aerial photography and construction plans. The map was divided into facilities, features, and sample units. A facility is defined as a complete area of the airfield that is used for a particular type of operation. Facilities are typically named for complete functional elements of pavement, such as Runway 11-29, Taxiway A, or North Terminal Apron. After facilities are defined, they are divided into features based on pavement type, construction, structure, and usage. Note that the terms branch and section may be used interchangeably with facility and feature throughout this report.

Features are divided into sample units as prescribed by ASTM D5340-11, *Standard Test Method for Airport Pavement Condition Index Surveys*. A sample unit is a subdivision of a section used exclusively to aid in the inspection process and reduce the effort needed to determine distress quantities and the PCI. The specified sample unit size for an asphalt concrete (AC) pavement is $5,000 \text{ ft}^2 \pm 2,000 \text{ ft}^2$. Sample units on portland cement concrete (PCC) pavements contain 20 ± 8 slabs.

To allow users to search, sort, and identify airport pavement quickly, a numbering system is used in conjunction with the facility, feature, and sample unit convention. The format starts with facility, then feature, and finally identifies the sample unit. The number 1605.300 is parsed as an example in Figure 1-1. Most pavement references in this report are presented in this format.

Using statistical sampling methods, the PCI procedure provides a high confidence level in evaluating overall pavement condition while sampling only a portion of the pavement surface. Table 1-2 shows the network-level inspection density used on this project. Where appropriate, “additional sample units” were identified and inspected to record pavement areas with distress patterns not representative of the overall pavement condition. The unique distress types documented in additional sample units are not extrapolated across the entire feature.

As the surveyors inspected the pavement, they were mindful to ensure that the pre-survey airfield map depicted the actual pavement, otherwise known as a “ground-truth” survey. Noticeable differences between what was present in the field and what was displayed on the maps were adjusted by a CADD technician.

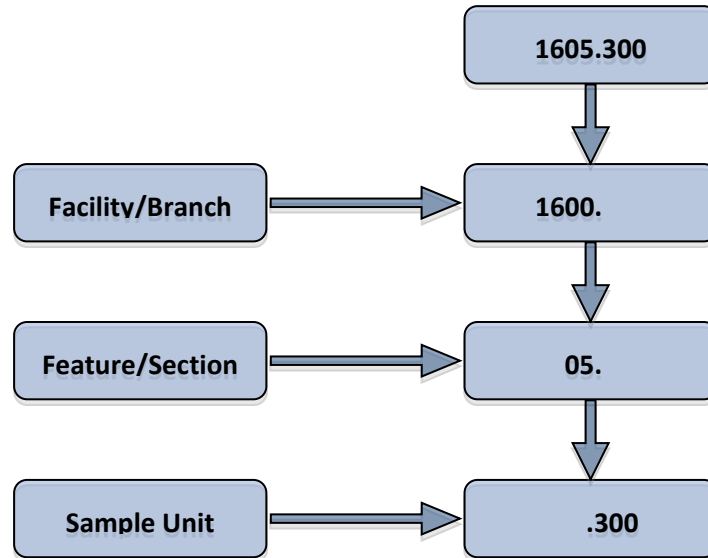

Figure 1-1. Pavement Numbering System

Table 1-2. Inspection Density

Sample Unit in Feature	Inspected Sample Units
1-2	ALL
3-4	2
5-7	3
8-10	4
11-14	5
15-19	6
20-25	7
26-30	8
31-37	9
38-45	10
46-55	11
56-80	12
> 80	15%

1.2.3 Conduct Airfield Condition Survey

The pavement condition surveys were performed in accordance with ASTM D5340-12. The procedure is based on the identification and measurement of visible distress at the pavement surface. Each PCI distress will deduct from the pavement's perfect condition of 100. Using pavement management software (or curves provided in ASTM D5340-12), a deduct value is determined for each combination of distress type, severity, and measured quantity. The PCI value is then determined from the unique combination of these variables.

A primary benefit of the PCI procedure is the ability to perform objective evaluations and compare pavement condition with an easy-to-understand numerical rating. Because the combined impact of multiple distresses is not cumulative, ASTM D5340-12 provides an additional family of curves to adjust for multiple distresses. The PCI is determined by applying the individual deduct value for each distress type along with any required correction factors to account for multiple distress types.

Figure 1-2 shows the relationship between PCI values and descriptive ratings. Generally, pavement maintenance is most cost-effective when the pavement is still in satisfactory condition. Rehabilitation, such as an asphalt mill and inlay, is typically performed for pavements with PCI values between 55 and 70. When the PCI value drops below 55, a mill an inlay may not provide the desired performance and complete reconstruction often becomes the most cost-effective means of repairing the pavement.

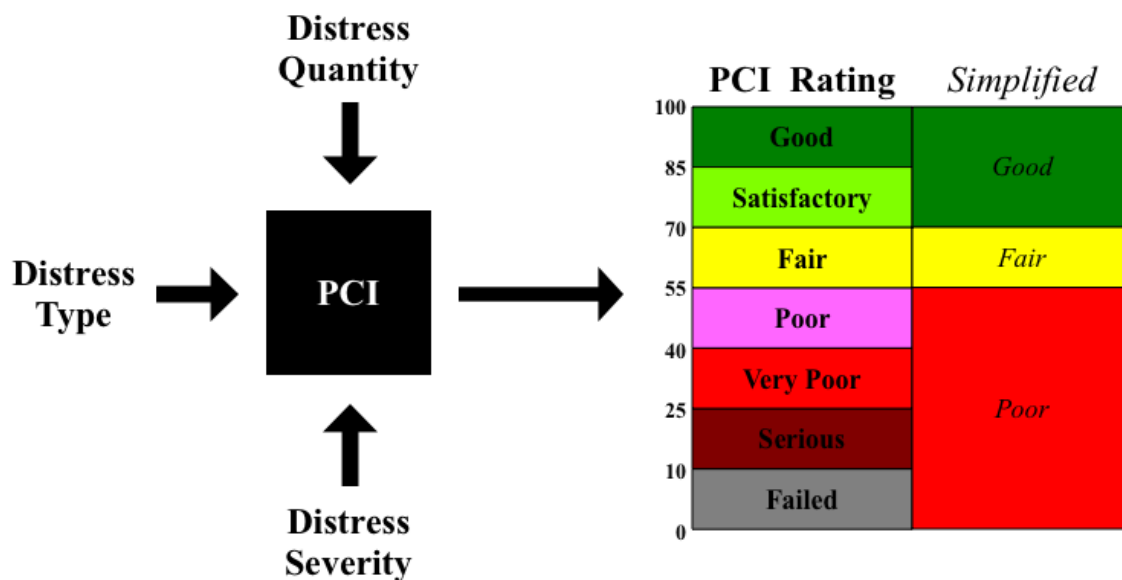

Figure 1-2. PCI Value and Descriptive Rating

1.2.4 Update AIRPAV Database & Software

The network definition, construction history, and data from the survey were entered into the AIRPAV pavement management system (APMS) software. After all data were entered, family curves were developed to model the change in pavement condition over time. These family curves are used to estimate future pavement condition. Typically, several curves are developed, with separate curves defined for different pavement surface types, such as AC, PCC, asphalt overlay on existing asphalt (ACC), and asphalt overlay on existing concrete (APC). The latest version of AIRPAV containing all survey data, deterioration curves, M&R policies, budgets, and construction history, was provided to INDOT on CD-ROM.

1.2.5 Develop 5-Year Airfield M&R Work Plans

A 5-year capital improvement program (CIP) was developed showing the year that each pavement feature was expected to fall below the MSL. The 5-year plan detailed in chapter 3 shows rehabilitation alternatives for each feature based on the PCI and the individual distress types observed during the pavement evaluation. The timing of each project is shown as the year that the PCI falls below the MSL and does not consider other important factors. Using reports like this for each airport in the State, INDOT engineers and planners develop a final 5-year statewide CIP plan that balances the sometimes conflicting priorities of pavement condition, operational constraints, construction staging considerations, and available funding.

1.2.6 Report Finding to INDOT

This report includes background information, PCI results and recommendations, and M&R budget scenarios. Photographs depicting typical pavement conditions observed during the survey are included in chapter 2. Appendix A contains general information about the AIRPAV pavement management software. Appendix B contains a summary of general maintenance techniques and best practices. Appendix C provides a detailed summary of the airfield pavement condition. Appendix D describes common airfield distress types. Appendix E provides an analysis of each pavement section based on recorded distress, and Appendix F contains exhibits to help the airport owner manage the airfield pavement system.

2. Pavement Condition Evaluation

2.1 Overview

Approximately 80,000 ft² of airside pavement is represented herein. Using statistical sampling methods approximately 2,900 ft² of AC pavement and 31,000 ft² of PCC pavement was surveyed as part of this assessment. The average inspected PCI for all pavements was 97 (Good). Table 2-1 provides a general description of the PCI rating categories, including a simplified rating scale of Good, Fair, and Poor. This table also shows the associated distress levels and general M&R requirements for each rating category.

Table 2-1. Definition and Distribution of PCI Ratings

Simplified PCI Rating	PCI Range	Definition	Pavement Area (ft ²)	Pavement Area (%)
Good	86-100	GOOD: Pavement has minor or no distresses and requires only routine maintenance.	75,742	96%
	71-85	SATISFACTORY: Pavement has scattered low-severity distresses that need only routine maintenance.	-	0%
Fair	56-70	FAIR: Pavement has a combination of generally low- and medium-severity distresses. M&R needs are routine to major in the near future.	2,862	4%
Poor	41-55	POOR: Pavement has low-, medium-, and high-severity distresses that probably cause some operational problems. Near-term maintenance and repair needs may range from routine up to a requirement for reconstruction.	-	-
	26-40	VERY POOR: Pavement has predominantly medium- and high-severity distresses that cause considerable maintenance and operational problems. Near-term maintenance and repair needs will be intensive in nature.	-	-
	11-25	SERIOUS: Pavement has mainly high-severity distresses that cause operational restrictions; immediate repairs are needed.	-	-
	0-10	FAILED: Pavement deterioration has progressed to the point that safe operations are no longer possible; complete reconstruction is required.	-	-

The pavement within each of the PCI condition categories is shown in Figure 2-1. The inspected PCI is summarized by branch use in Figure 2-2, and the photographs in Figure 2-3 through Figure 2-4 provide examples of the condition categories.

INDIANAPOLIS DOWNTOWN HELIPORT 2014 PCI Inspection

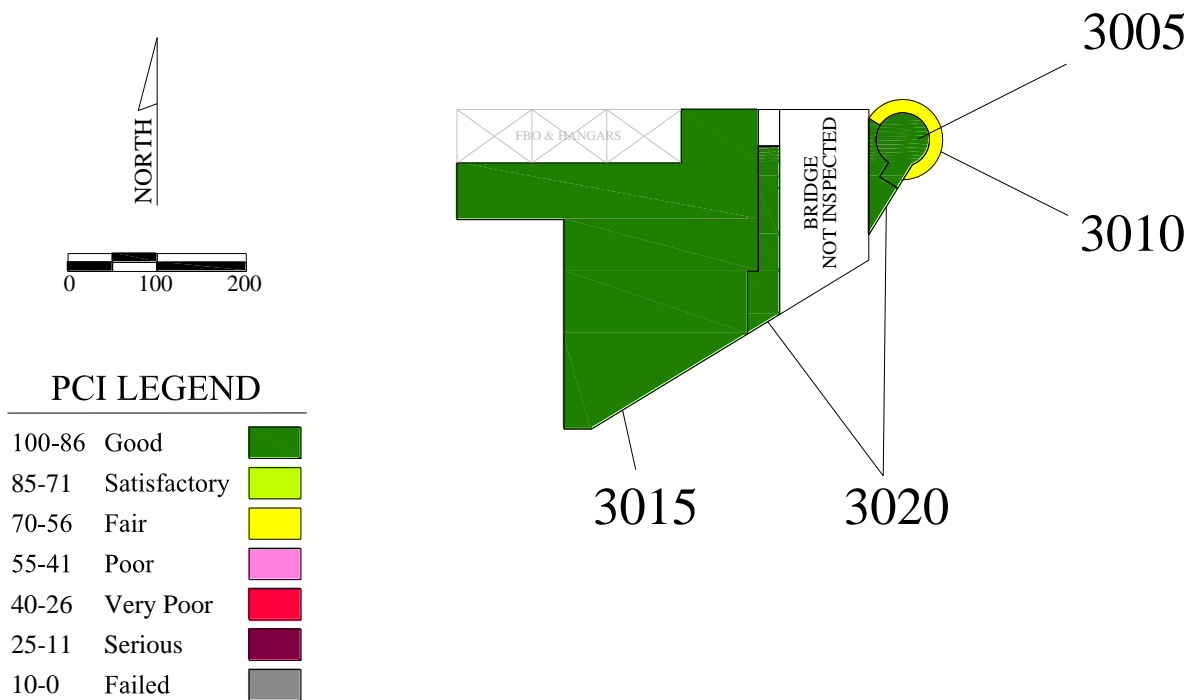

Figure 2-1. Inspected Pavement Condition

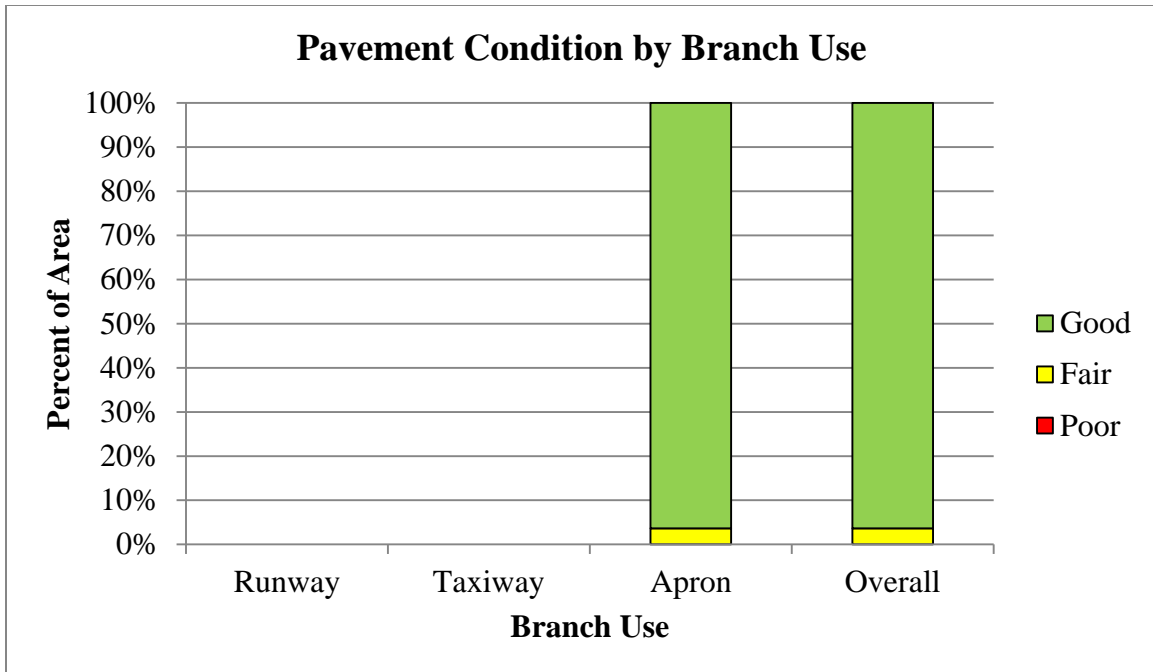

Figure 2-2. Pavement Condition by Branch Use



Figure 2-3. Typical Good PCC Pavement (Feature 3015)



Figure 2-4. Typical Fair AC Pavement (Feature 3010)

2.2 Distress Types and Frequency

The inspectors surveyed approximately 2,900 ft² of AC pavement. The frequency of each distress type is shown in Table 2-2. The recorded distress types included longitudinal and transverse (L&T) cracking, patching, and ravelling. L&T cracking is an age-related distress. Ravelling is a climate-related distress.

Table 2-2. Distress Frequency in AC Pavement

Distress	Sample Units	% Inspected Sample Units
L&T CRACKING	1	100
PATCHING	1	100
RAVELING	1	100

The inspectors surveyed approximately 31,000 ft² of PCC pavement. The frequency of each distress type is shown in Table 2-3. The most common distress types were patching. Patching is an indicator of an active maintenance program.

Table 2-3. Distress Frequency in PCC Pavement

Distress	Sample Units	% Inspected Sample Units	Slabs	% Inspected Slabs
PATCHING SMALL	4	29	7	3
PATCHING LARGE	2	14	2	1
CORNER BREAK	1	7	1	0

2.3 PCI Summary

The branch and section PCI values are shown below, along with the surface type, area, and last year construction occurred.

Table 2-4. PCI Results

Branch ID	Branch PCI	Section	Surface	Area (sf)	Built	2011 PCI	2013 PCI
3000	97	3005	PCC	3,282	1985	98	98
		3010	AC	2,862	1985	63	62
		3015	PCC	66,060	1985	98	98
		3020	PCC	6,400	1993	80	100

2.4 Analysis Commentary

The following pages provide a brief overview of the 2014 inspected pavement conditions for each facility. Comments are based primarily on the AIRPAV analysis but also include field notes and remarks from the pavement condition inspectors. Where appropriate, individual pavement sections are referenced within the larger facility.

Section 3020 has undergone extensive patching and rehabilitation since last inspection. Also, the total section area has changed and consequently PCI has improved since the last inspection.

2.4.1 Aprons

The aprons consisted of three sections of PCC, and one section of AC. The total area of apron pavements was 78,604 ft², and the area-weighted average PCI was 97 (Good). The distribution of pavement area and sections by PCI range are shown in Table 2-5.

Table 2-5. Apron Condition Distribution

PCI Range	Rating	Number of Sections	Pavement Area (ft ²)	Pavement Area (%)
100-71	Good	3	75,742	96%
70-56	Fair	1	2,862	4%
55-0	Poor	-	-	0%

3. Capital Improvement Program

3.1 Analysis

The individual feature analyses shown in appendix E document viable rehabilitation projects that address the causes of each pavement section failure while restoring the pavement to a condition above the desired MSL. The recommended timing of each improvement action is defined as the year that the pavement condition is projected to reach the MSL. By establishing benchmark MSL targets, it is possible to plan objectively for future needs against a standard set of performance criteria. This section categorizes the identified viable options into CIP strategies based on cost and expected service life.

The airport may find it desirable to adjust the timing of projects detailed in the CIP to meet fiscal and operational constraints. For example, if different sections of a runway were projected to reach the MSL in various years ranging from 2016 to 2018, it is not operationally feasible to stage rehabilitation over a 3-year period. Instead, runway rehabilitation would be programmed in a manner that balanced the need to minimize the length of the runway closure while maximizing the remaining service life.

3.2 Cost Estimates

Project costs were estimated based on the pavement area and the unit costs shown in Table 3-1 for specific M&R activities. Project costs are presented so planners and managers can compare the relative magnitude of funding required for various alternatives. The two-page AIRPAV feature analysis (see appendix E) provides cost estimates for each identified project. These cost estimates are for planning purposes only and do not constitute an engineering estimate.

Furthermore, these cost estimates represent the improvement of existing pavement structures and associated incidental work only. Other potential project line items, such as lighting, navigational aids, and drainage modifications are not included, and estimates for those items must be developed separately and incorporated into an overall project cost.

Typical examples of work that might be included in alternatives evaluated by AIRPAV are outlined on the following pages. These example projects would meet the requirements for each selected option; however, the descriptions are not intended to imply required, or even preferred, design configurations. Rehabilitation decisions, such as overlay thickness design, should be made in conjunction with engineering design analysis.

Table 3-1. Unit Costs

Rigid Pavement (PCC)	
Reconstruction	\$12.90 /sf
Slab Replacement & Full Depth Patching	\$12.48 /sf
Patching (Partial Depth)	\$16.70 /sf
Slab Repair & Overlay	\$4.69 /sf + \$0.41 /sf/in > 4"
Joint Seal Replacement	\$2.24 /lf
Joint Seal Repair	\$0.87 /lf
Undersealing	\$4.16 /sf
Flexible Pavement (AC)	
Reconstruction	\$5.36 /sf
Resurfacing	\$1.44 /sf
Structural Overlay	\$2.25 /sf + \$0.41 /sf/in > 4"
Surface Treatment	\$0.39 /sf
Patching	\$9.78 /lf
Crack Repair (Restorative)	\$1.24 /lf
Crack Repair (Sustaining)	\$0.85 /lf

3.2.1 Rigid Pavement Work Descriptions

The following descriptions provide additional information about the typical work items covered by the unit costs shown in Table 3-1.

3.2.1.1 Reconstruction

Reconstruction is recommended when the pavement defects would not be corrected by less extensive measures. Unit prices assume removal of the existing pavement to the subgrade and reconstruction with 8 inches of high strength PCC pavement on 6 inches of aggregate subbase.



3.2.1.2 Repair and Overlay

This procedure usually consists of a rubblize or a crack and seat process, where the existing pavement is broken into segments of approximately 2 ft on a side by dropping a heavy breaker bar onto the pavement. Properly done, aggregate interlock between pavement segments is retained and reflective cracking is reduced. A flexible surface is then placed over the recycled PCC base.



3.2.1.3 Slab Replacement

Slab replacements are typically required for high-severity blow ups, scaling, and shattered slabs. Unit prices assume removal of the selected slab to the subgrade. Prepare subgrade to bearing strength equivalent to surrounding subgrade. Provide subbase support equivalent to existing and install load transfer steel as required. Place PCC pavement level with existing surface.



3.2.1.4 Patching (Partial Depth)

While partial depth patching is most commonly used to repair joint and corner spalls, it is effective for a wide variety of distress types. Saw cut and remove area of pavement to sound concrete above reinforcing steel. Treat existing concrete to ensure firm bond. Place PCC level with existing surface.



3.2.1.5 Joint Seal Replacement

Rout joints and cracks to a depth of at least 1-1/4 inches, clean joint wall surfaces to expose fresh vital concrete, install backing rope, and apply rubberized sealant meeting ASTM D3405 specification, or equivalent.



3.2.1.6 Joint Seal Repair

Press existing sealant into joint for use as backer material; apply joint sealant meeting ASTM D3405 specification, or equivalent.

3.2.1.7 Undersealing

Undersealing is used to repair faulting between slabs or when corner breaks have settled relative to the slab. High-pressure injection is used to force material into the underlying voids and continues until the settled pavement is restored to its original elevation. Several materials have been used for undersealing, including cement grout, asphalt slurries, and proprietary formulations of expansive Styrofoam.



3.2.2 Flexible Pavement Work Descriptions

3.2.2.1 Reconstruction

Reconstruction is recommended when the pavement defects would not be corrected by less extensive measures. Unit prices assume removal of existing pavement to subgrade. Scarify and compact subgrade to 6-inch depth. Construct 4 inches of P401 AC surface course on 8 inches of aggregate base course.



3.2.2.2 Resurfacing

Resurfacing assumes a nominal 2-inch asphalt mill and inlay on existing prepared pavement.



3.2.2.3 Structural Overlay

Structural overlays are used to address load related distress or to increase pavement load bearing capacity. Apply a 4-inch AC overlay on existing prepared pavement. Add additional thickness as needed to achieve required strength.

3.2.2.4 Surface Treatment

Apply a high-quality, penetrating rejuvenating sealer



3.2.2.5 Patching

High-performance cold patching products can be used for short term repairs. Long-term patches should be made with plant mixed hot asphalt meeting FAA P401 specs.

3.2.2.6 Crack Repair (Restorative)

Rout existing crack to a minimum depth of 1-1/4 inches, install backing rope and apply rubberized crack filler meeting ASTM D3405 specification.

3.2.2.7 Crack Repair (Sustaining)

This is typically spot repairs of existing crack sealant.



3.3 Capital Improvement Strategies

Figure 3-1 shows a projection of the overall airport pavement condition for the next 10 years based on implementing one of three capital improvement strategies:

- No Action: No capital improvement action is undertaken
- Longest Life: The most comprehensive repair and longest life rehabilitation option
- Lowest Cost: The rehabilitation option with the projected lowest annual cost

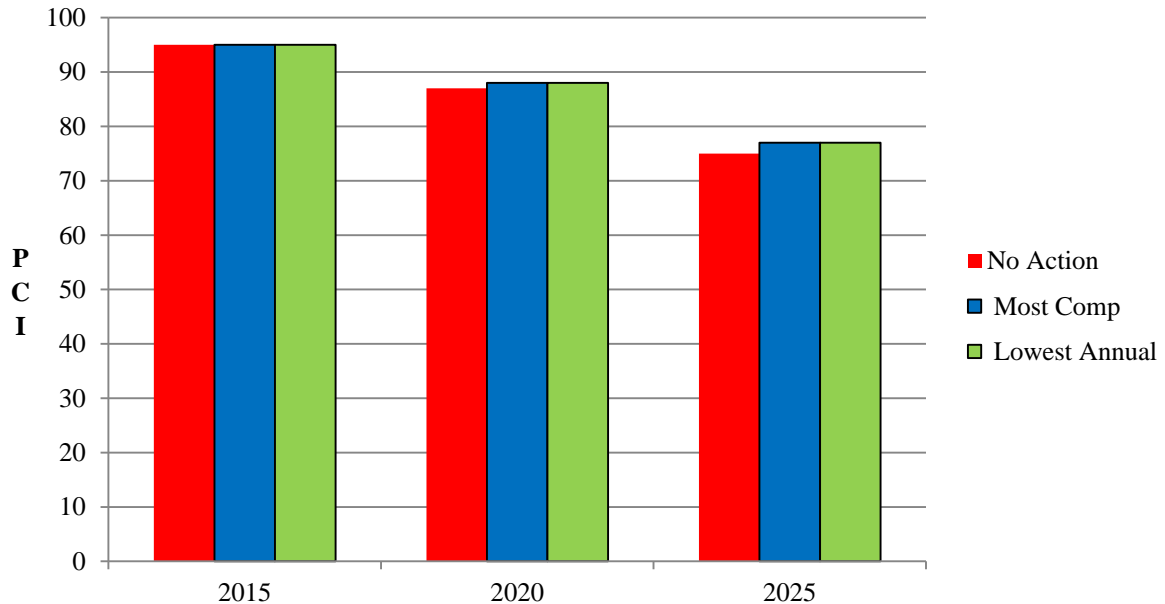

Figure 3-1. Programmed CIP

The longest life CIP scenario for all of the pavement projected to fall below the MSL is projected to cost approximately **\$4,100** over the next 10 years. The corresponding lowest annual cost scenario is also projected to cost approximately **\$4,100** over the next 10 years. Examples of each capital improvement strategy and a complete listing of all viable capital projects are presented in Table 3-2 through Table 3-4.

Table 3-2. Most Comprehensive Repair

Feature	Built	Description	Action Yr	Work Item	Cost, \$
3010	1985	RAMP	2017	Resurfacing	4,121
Total					4,121

Table 3-3. Lowest Annual Cost Repair

Feature	Built	Description	Action Yr	Work Item	Cost, \$
3010	1985	RAMP	2017	Resurfacing	4,121
Total					4,121

Table 3-4. All Viable Options

Feature	Built	Description	Action Yr	Work Item	Cost, \$
3010	1985	RAMP	2017	Crack Repair	462
3010	1985	RAMP	2017	Surface Treatment	1,142
3010	1985	RAMP	2017	Resurfacing	4,121

4. Maintenance Management Program

4.1 General Comments

Most pavement distress is classified by severity (low, medium, or high). As a general rule, high-severity distresses should be patched, and medium-severity distress should be sealed. A detailed matrix of recommended maintenance policies to address various distress types is provided near the end of this section.

4.1.1 Inspected Crack Severity

Of the inspected pavement, 100 percent of the cracks were rated at low severity and require no maintenance beyond ongoing inspection and spot repair.

4.1.2 Other Distress

The inspected asphalt pavement area measured distresses such as rutting, depressions, fatigue cracks, and raveling were recorded as follows: 75 percent at low severity, none at medium severity, and 25 percent at high severity.

Joint seal damage was not a recorded distress in PCC pavements.

4.2 Recommended Maintenance Actions

The following illustrations and tables show pavement areas that have maintenance and repair needs. Ongoing development of capital improvement projects may address some of these maintenance needs. To help budgeting and prevent duplication of effort, all pavement features recommended for maintenance should be compared to planned improvements prior to finalizing a maintenance program strategy.

Table 4-1. Recommend Maintenance Actions

Work Item	Quantity	Unit	Cost
AC SUSTAINING CRACK REPAIR	55	LF	48
Total:			\$ 48

4.2.1 Crack Seal

Table 4-2. Recommend AC Sustaining Crack Repair

Feature	Work Item	Amount	Insp. PCI	Change	Est. PCI
3010	AC SUSTAINING CRACK REPAIR	55 L.F.	62		N/A
EQUIPMENT: AIR COMPRESSOR, HEATING KETTLE, HAND TOOLS					
EST. MATERIALS: 11 POUNDS ASTM D3405 SEALANT OR EQUIVALENT					
EST. MATERIAL COST: \$11					
EST. CREW HOURS: .2					
EST. CREW COST: \$37					
EST. PROJECT COST: \$48					

INDIANAPOLIS DOWNTOWN HELIPORT 2014 PCI Inspection

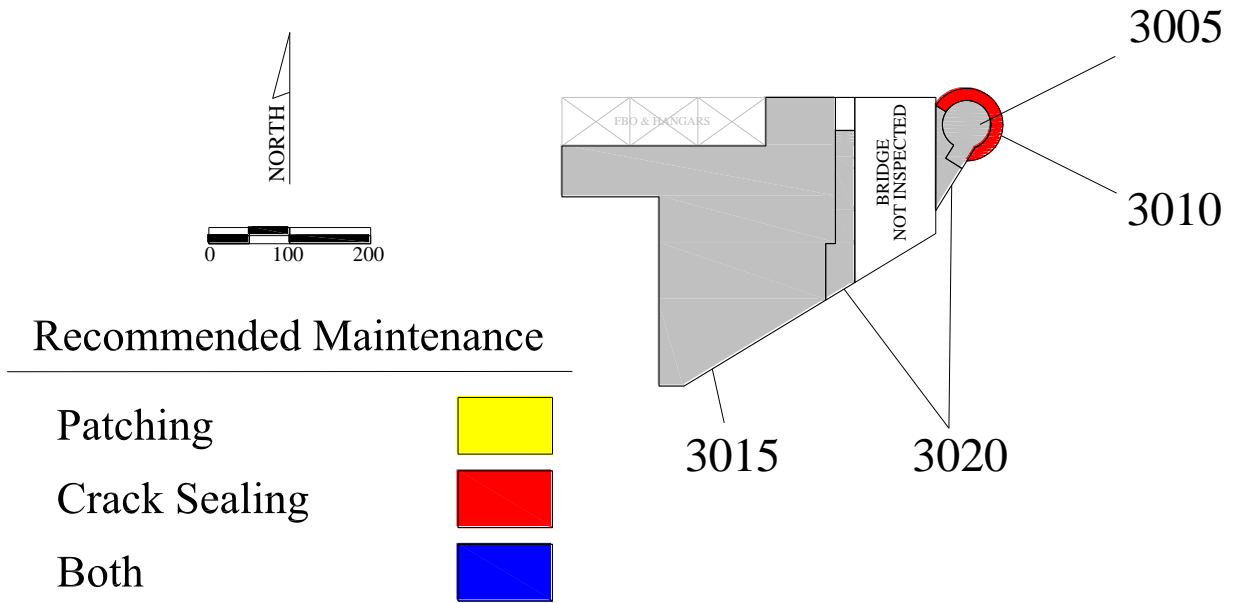

Figure 4-1. Recommended Maintenance

4.3 Pavement Deterioration

Before attempting maintenance and repairs, it helps to understand pavement performance and pavement deterioration. The factors that contribute most to deterioration are environmental, materials, and/or load related. Brief discussions of each are presented in the following sections.

4.3.1 Environmental/Age-Related Deterioration

Seasonal and daily temperature changes cause expansion and contraction of the pavement materials. The shear stresses created by expansion and contraction can cause transverse cracking in flexible pavement and mid-slab cracking in rigid pavement. Further, expansion and contraction will cause cracks, and rigid pavement joints, to open and close with changes in temperature.

Flexible pavement oxidizes as it ages, losing its lighter, volatile, components and becoming brittle with time. Surface treatments and seal coats are designed, in part, to provide a protective barrier and prevent this type of oxidation.

Subsurface water can have the greatest impact on pavement deterioration. A wet subgrade greatly reduces the ability of a pavement to support wheel loads, and the results often show up as rutting and cracking of flexible pavement. The fine materials in a wet base can be pumped up through the cracks and eventually result in a loss of support. This loss of support can be evidenced as corner breaks and faulting in rigid pavement. Moisture inside a pavement system expands when it freezes, creating stresses that cause the pavement surface to heave. Subsequent freeze-thaw cycles leave voids in the pavement structure that enable further rutting and breaking. Repeated freeze-thaw cycles eventually cause the pavement to disintegrate. Freeze-thaw deterioration requires frost-susceptible material, sub-zero temperatures, and water. If one of these factors is removed, freeze-thaw damage will not occur. One of the best ways to ensure pavement longevity is to provide drainage and keep it dry.

4.3.2 Materials-Related Deterioration

The pavement thickness and type of subgrade play a large role in the formation and spacing of transverse cracks. If the subgrade and base materials are smooth or rounded and allow for relatively free movement of the pavement surface, transverse cracks will often be spaced far apart (>60 feet). If the subgrade and base material are rough or angular and provide greater resistance to movement of the pavement surface, transverse cracks will be spaced more closely (<40 feet). The distance between transverse cracks also depends on the pavement thickness, as a thicker pavement can resist cracking for longer lengths. At general aviation airport pavements, around 50 feet is typical transverse crack spacing.

Aggregate is the biggest component of any pavement structure, and it is the contact between the aggregate particles that actually transfers the load and provides the strength. Aggregate durability and shape are major factors affecting pavement performance. Durability is the ability of the aggregate to perform satisfactorily over time and resist deterioration. Sharp, well-angled aggregates that interlock, compact densely, and resist movement are the most desirable.

In flexible pavement, the selection of asphalt cement can have a significant impact on pavement performance. Asphalt is visco-elastic, which means it is stiff at low temperatures and flows at high temperatures. With this in mind, asphalt pavement should be designed to remain stiff on hot summer days to resist plastic deformation (rutting and shoving). In addition asphalt pavement should have sufficient cold temperature flexibility on cold winter days to resist transverse cracking. The proper selection of asphalt cement grade and maintaining adequate mix volumetrics (air voids, voids in the mineral aggregate, etc.) are key factors in the performance of flexible pavement.

As water freezes, it expands and occupies a greater volume than in a liquid state. In PCC pavement, interconnected, well-distributed air voids are required to allow for expansion of moisture with the PCC. PCC mixes with insufficient air entrainment are susceptible to freeze-thaw damage, as the expansive forces have been shown to cause concrete deterioration. Small, closely spaced, interconnected air voids provide the greatest degree of protection.

Asphalt paving mixes also require air voids, but for reasons different than for PCC pavement. When a well-constructed asphalt pavement is subjected to vehicle loading, it will nevertheless experience some minor secondary consolidation. Air voids allow for the safe movement of the asphalt binder within the mix. With insufficient air voids, the asphalt binder will migrate to the surface of the pavement—it will in essence, get squeezed out of the mix. This phenomenon is called flushing. In addition, these mixes become unstable and are prone to rutting in the wheel paths.

However, if the air voids become too high, air and water can penetrate the pavement, reducing both durability and flexibility. Air infiltration will accelerate oxidization of the binder, while water penetration will increase the moisture susceptibility of the mix (i.e., stripping of the asphalt cement from the aggregate). Air voids in flexible pavement should be kept low enough to prevent water and air from penetrating the asphalt layers, but high enough to minimize the potential of plastic deformation.

Regardless of whether the pavement binder is AC or PCC, binder materials are mixed with aggregate to coat all aggregate particles with a thin binder film. Durability of flexible asphalt pavement is increased with a thicker binder film, and the pavement becomes more resistant to age hardening; however, if the film is too thick, the asphalt acts like a lubricant, promoting ruts, shoving, and bleeding. Each asphalt mix should be customized for materials available locally.

With a concrete pavement, aggregate interlock supports the wheel loads, and the hydrated cement binder further interlocks the aggregate particles to inhibit all movement. “Hydration” is the term for the chemical reaction of portland cement with water. In the hydration process, dry cement particles react with water to form gels, and then crystals, that grow and bond with the aggregate and form a rigid interlocking structure. Hydration can continue for years, but much of the ultimate strength will be reached within 28 days. Hydration is a sensitive chemical process. Typically, any admixtures used to accelerate the hydration process will reduce durability, and admixture use should be considered carefully or avoided.

4.3.3 Load-Related Deterioration

As illustrated below, rigid and flexible pavements differ in the way loads are distributed. A concrete slab resists bending and transfers loads evenly, while an asphalt pavement is designed to bend, gradually spreading loads over wider areas.

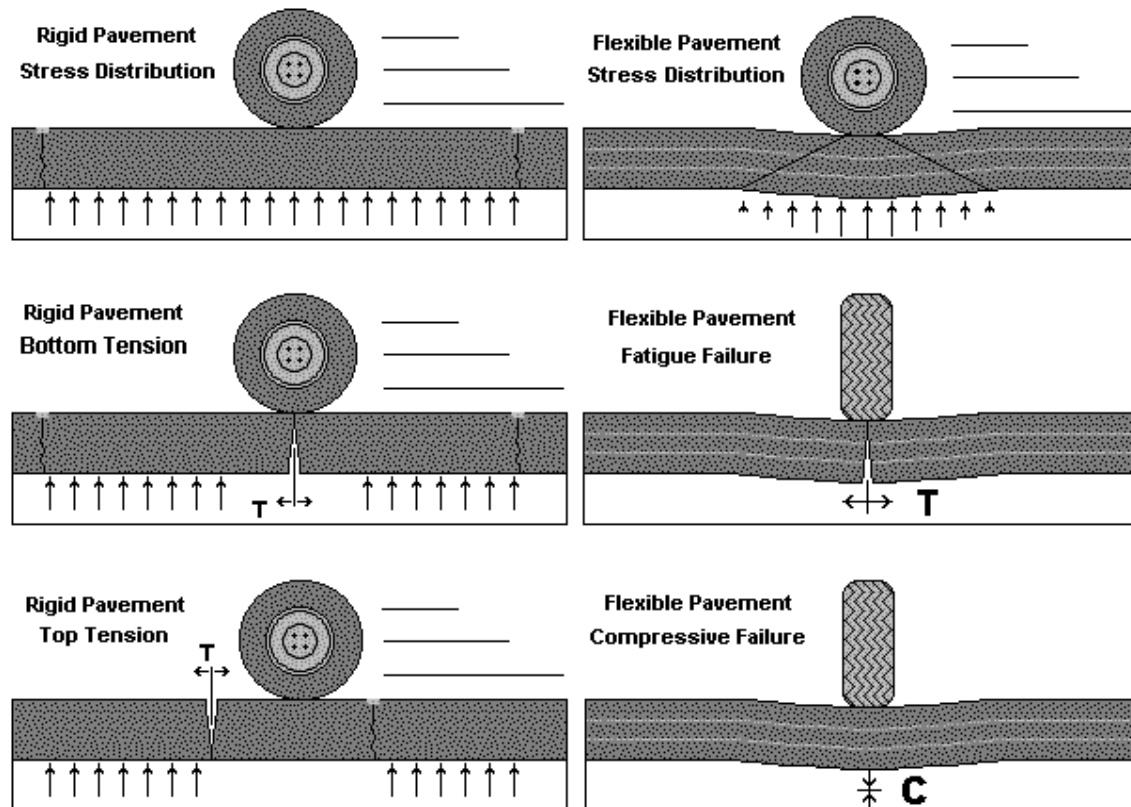

Load-related cracks can start at the top or bottom of a pavement section. In asphalt sections, load-related (fatigue) cracks start at the bottom. If a load-related crack reaches the surface, it usually indicates structural deficiency. In rigid pavement, corner breaks are caused by tensile forces at the top of the slab, and the crack propagates downward. Mid-slab LTD cracks are distress examples resulting from tensile forces at the bottom of the slab.

Both wheel loads and environmental factors can cause spalls anytime there is movement between adjacent slabs. If non-compressible material (such as a small rock) is allowed into a joint, stresses will build up between adjacent slabs and can cause a spall. Keeping joint and crack sealant intact can help to reduce the infiltration of non-compressible material and minimize spalling.

4.4 Best Practices

4.4.1 Flexible Pavement

L&T cracks at medium severity should be filled with a good quality crack sealant material. High-severity cracks normally must be patched.

Cracks rated at low severity may be narrow unsealed cracks or sealed cracks up to 3 inches wide. The PCI procedure does not distinguish between narrow unfilled cracks and wider filled cracks. Some L&T cracks at low severity are included in the estimated sealing quantities and costs in this maintenance plan. In general, when medium- or high-severity cracking constitutes less than 25 percent of the total crack quantity, sustaining maintenance usually is more cost-effective. When 25 percent or more of the total crack quantity is at medium or high severity, a restorative program typically becomes more cost-effective.

Existing patches rated as medium and high severity should be replaced with new patches. Small areas (usually less than 100 square feet per patch) of alligator cracking and rutting at medium and high severity also may be repaired cost-effectively by patching. Larger patches should be considered if equipment can be made available to accomplish the work. Patching to repair up to 10 percent of the surface of a pavement feature that is otherwise serviceable can result in significant cost savings as compared to rehabilitation of the entire feature.

An example maintenance policy treatment matrix for flexible pavement is shown in Table 4-3. Examples of various maintenance techniques are provided in appendix B.

4.4.2 Rigid Pavement

Joint seal damage rated at medium and high severity should be repaired. If medium- and high-severity damage is limited to less than about 25 percent of the total joint length, sustaining maintenance is recommended. If medium- and high-severity damage exceeds 25 percent of the total joint length, the joint sealant should be removed and replaced under a restorative repair project.

LTD cracks at low and medium severity should be considered for sealing as part of the joint sealing project. High-severity LTD cracks require sealing, patching, or slab replacement, depending on the extent of deterioration.

Small patches are typically used to repair medium- and high-severity spalls or to replace deteriorated older patches. Restorative small patches are typically partial-depth repairs, usually to a maximum depth of 1/3 the slab thickness. Large patches and corner breaks at medium and high severity should be repaired by full-depth large patches.

High-severity LTD cracks and shattered slabs are candidates for patching and slab replacement. Low-severity shattered slabs can be left in place pending further deterioration.

An example maintenance policy treatment matrix for rigid pavement is shown in Table 4-3. Examples of various maintenance techniques are provided in appendix B.

Table 4-3. General Maintenance Policy (AC)

Distress Type	Distress Severity	Maintenance Action
Alligator Cracking	Low	Crack Sealing - AC
	Medium	Patching - AC Deep
	High	Patching - AC Deep
Bleeding	N/A	Monitor
Depression	Low	Monitor
	Medium	Patching - AC Shallow
	High	Patching - AC Deep
Jet Blast	N/A	Patching - AC Shallow
Longitudinal, Transverse, Joint Reflective, & Block Cracking	Low	Monitor
	Medium	Crack Sealing - AC
	High	Patching - AC Deep
Oil Spill	N/A	Patching - AC Shallow
Patching	Low	Monitor
	Medium	Crack Sealing - AC
	High	Patching - AC Deep
Polished Aggregate	N/A	Monitor
Weathering / Raveling	Low	Monitor
	Medium	Surface Treatment
	High	Patching - AC Shallow
Rutting, Corrugation and Swell	Low	Monitor
	Medium	Patching - AC Deep
	High	Patching - AC Deep
Shoving	Low	Monitor
	Medium	Patching - AC Shallow
	High	Patching - AC Deep
Slippage Cracking	N/A	Patching - AC Shallow

Table 4-4. General Maintenance Policy (PCC)

Distress Type	Distress Severity	Maintenance Action
Blow Up	Low	Patching - PCC Partial Depth
	Medium	Slab Replacement - PCC
	High	Slab Replacement - PCC
Longitudinal, Transverse & Diagonal Cracking	Low	Monitor
	Medium	Crack Sealing - PCC
	High	Patching - PCC Full Depth
Durability Cracking	Low	Monitor
	Medium	Patching - PCC Full Depth
	High	Slab Replacement - PCC
Large Patch & Corner Break	Low	Monitor
	Medium	Patching - PCC Full Depth
	High	Patching - PCC Full Depth
Popout / Shrinkage Cracks	N/A	Monitor
Scaling	Low	Monitor
	Medium	Patching - PCC Partial Depth
	High	Slab Replacement - PCC
Faulting	Low	Monitor
	Medium	Grinding (Localized)
	High	Grinding (Localized)
Shattered Slab	Low	Monitor
	Medium	Crack Sealing - PCC
	High	Slab Replacement - PCC
Joint Spall, Corner Spall & Small Patch	Low	Monitor
	Medium	Patching - PCC Partial Depth
	High	Patching - PCC Partial Depth
Alkali Silica Reaction	Low	Monitor
	Medium	Slab Replacement - PCC
	High	Slab Replacement - PCC

4.5 Pavement Repair Materials

New pavement repair materials are introduced and improved regularly. This section provides information on products compatible with airport needs.

4.5.1 Joint and Crack Sealer

Hot-poured, pressure-injected, polymeric rubberized asphalt sealant meeting ASTM D3405 specifications is suitable for most sealing requirements. This product is relatively inexpensive, durable, and suitable for both rigid and flexible pavements. Other, more expensive, hot-applied sealants that promise longer life are being developed for specialty applications. Twin component cold applied sealants also have been used with success. Contact your local distributor.

4.5.2 Flexible Pavement Patch

High-performance plant mixed cold patching products that can be stockpiled on-site can be used for short term repairs to maintain safety. Long-term patches should be made with high-quality plant mixed hot asphalt having a $\frac{3}{4}$ -inch maximum aggregate size and meeting Federal Aviation Administration (FAA) P401, or highest quality highway specifications. Low-quality packaged materials available from local hardware type stores should be avoided.

4.5.3 Rigid Pavement Patch

Permanent patches in rigid pavement should be made with air-entrained concrete with 1-inch maximum size aggregate. If the area must be quickly opened to traffic, high early concrete should be considered. Concrete should have zero slump and a coarse texture. As with asphalt patches, low-quality packaged materials should be used only as temporary patches to maintain safety and service until a more permanent repair can be made.

4.6 Pavement Repair Equipment

Many pavement repair and sealing products are available. Specialized tools and equipment help ensure high-quality repairs. This section discusses equipment compatible with airport needs.

4.6.1 Air Compressor

Used to remove non-compressible sand and debris from prepared cracks and joints, the compressor should have a sustained capacity of 120 cubic feet per minute with a nozzle velocity of 100 psi. Trailer-mounted compressors typically have capacities in this range.

4.6.2 Concrete Saw

A saw capable of making a minimum 3-inch-deep cut is required. The saw should be capable of making cuts in both asphalt and concrete. Gasoline-powered 5- to 25-hp wheel-mounted saws typically are preferred for this type of work, but electric and pneumatic tools also are available.

4.6.3 Heating Kettle

Applying sealant is the most time-consuming operation, and a sealing machine with heating and pressure application capabilities is a critical item in a successful sealing program. The capacity of the sealing equipment dictates the rate at which a crew progresses. For large sealing projects, a minimum 100-gallons/hour sustained capacity is recommended. The unit should be a double boiler type, with mechanical agitators or continuous recirculation. Kettle temperature must be monitored to ensure that the sealant is not “burned.” Overheating the sealant will prematurely age harden the material.

4.6.4 Router

A concrete saw can be used to prepare joints, but for random cracking, a mechanical router with a vertical impact mechanism is preferred. When cracks are being routed, this activity will dictate the speed of the crew. Crack routers in the 25-hp range are commonly used and are available from a variety of manufacturers.

4.6.5 Sand Cleaner

A sand blaster helps to clean loose particles and dust from prepared cracks. The unit must have sufficient force to expose fresh, vital pavement to bond with sealant and patching materials.

4.6.6 Vibratory Roller or Plate Compactor

Required to compact plant mixed and packaged patching materials properly. Small rollers are best for pothole type applications; plate compactors are best for large areas.

4.6.7 Other Equipment

Other general use equipment that can be helpful in a maintenance program includes bucket loaders, dump trucks, water tanks, and a power sweeper unit.

Appendix A. AIRPAV Software

The Software

Data analysis was performed using the AIRPAV pavement evaluation and management software. In addition to calculating and documenting PCI values, AIRPAV evaluates the collected inspection data and recommends rehabilitation actions that address the cause of pavement distress. AIRPAV can incorporate traffic and structural capacity evaluations into the pavement evaluation matrix, and AIRPAV also performs preliminary life cycle cost analysis of the various rehabilitation alternatives, providing guidance on the lowest annual cost repair strategy.



A complete database, along with an updated version of AIRPAV, is provided on INDOT computers for ongoing management of the INDOT pavement systems.

Capital Improvements

AIRPAV creates interactive CIPs, providing the user with the ability to input unit costs, develop new projects, move projects between years, and even increase or decrease the scope and cost of individual projects.

Maintenance

AIRPAV calculates and develops maintenance work orders organized by type of work. Maintenance work orders can be printed and issued directly to maintenance crews.

Traffic

AIRPAV provides the ability to model aircraft ground movements. Traffic can be sorted by airline, aircraft type, destination gate or ramp, and runway used. The program graphically displays each taxi path, accumulates total operations, automatically determines design aircraft, and calculates structural overlay requirements for each pavement feature. The software can provide Pavement Classification Numbers (PCN) for each pavement feature or report results directly as inches of overlay required.

Maps

AIRPAV permits viewing and printing of PCI maps. Inspection layout, pavement condition, and other views are available from within the software.

Query

The AIRPAV query function is a powerful search tool that allows users to extract useful reports meeting various criteria. For example, lists can be created for taxiway pavement, asphalt pavement, or areas below MSL at the time of inspection.

Global Information System (GIS) Integration

AIRPAV is fully GIS-enabled. A single click in AIRPAV exports all data to an MS Access database that can be linked to shape files used in an ESRI product. In this way, virtually all data in the pavement management database can be accessed in GIS format.

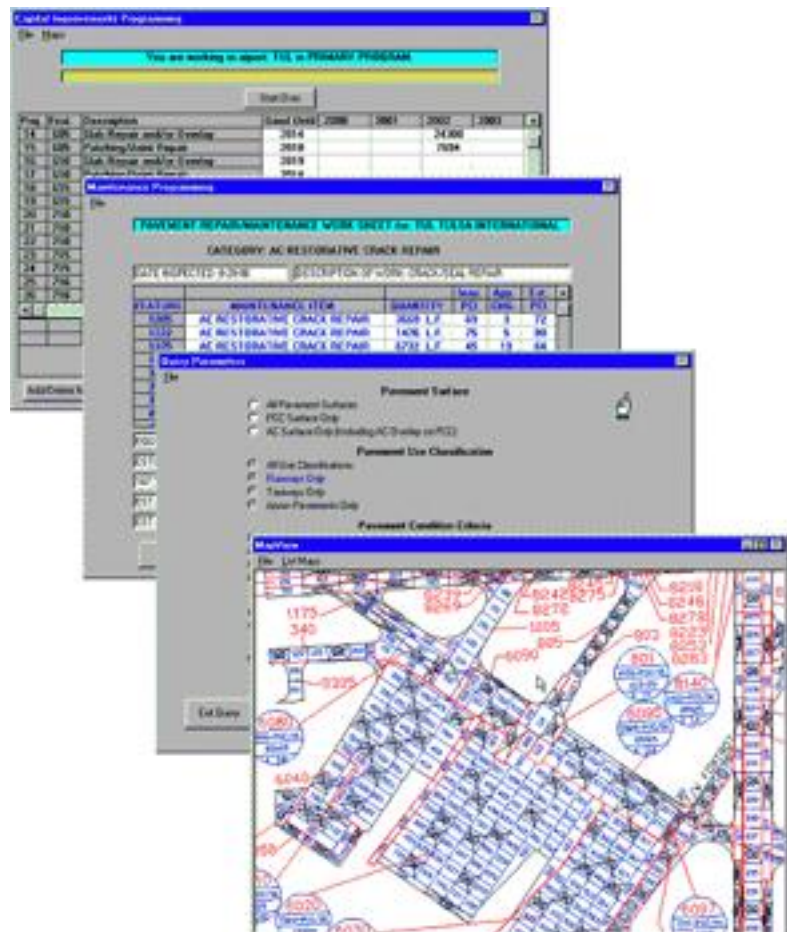

Appendix B. General Maintenance Techniques

Crack Sealing

- Cracks over ¼ inches wide should be sealed.
- Cracks wider than 3 inches should be patched.
- Sealant depth above the backer rope should be equal to the width of the reservoir, or as recommended by the manufacturer.
- Routed cracks should be sand blasted, to prepare for bonding with the sealant.
- Clean cracks with compressed air prior to sealing.
- Backing material should always be placed into the cracks. Commercial products are available. Several sizes of rope should be available to accommodate various crack sizes.
- Apply sealant after placing the backer rope. Follow the manufacturer's instructions. Sealant should be applied to within ¼ inch of the pavement surface.
- The final activity is to clean the surrounding pavement areas. A vacuum sweeper works well for this. Allow the sealant time to set before using a broom.
- Consider hot-applied, pourable patch material for cracks > ½ inch and any subsidence or depressions.

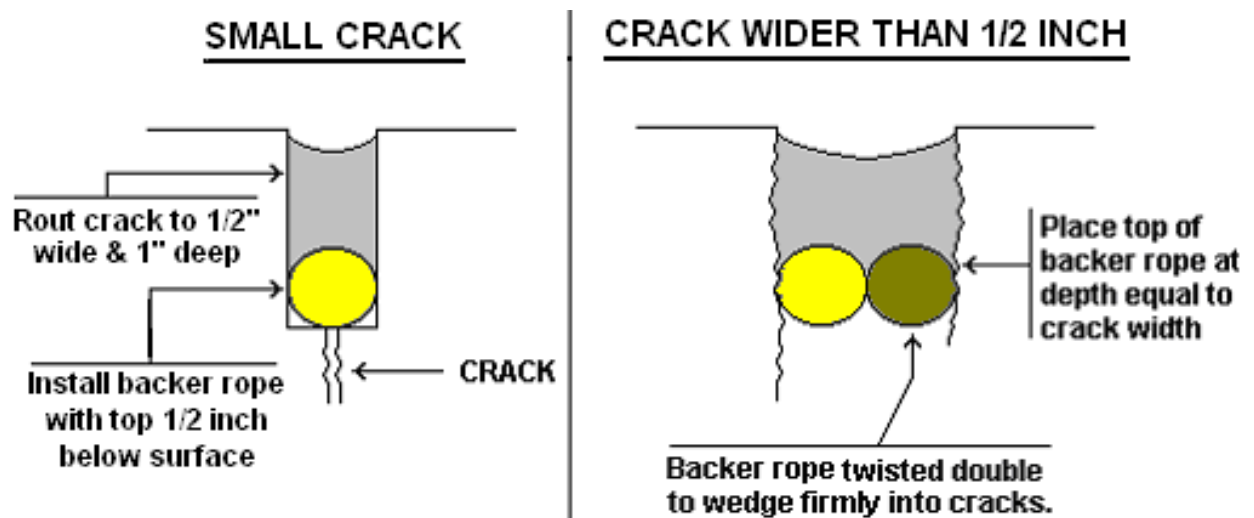

Overband Technique

An alternate crack sealing technique using the procedures outlined below.

Material

- Blend grade 20 or equivalent asphalt cement and latex rubber at 5 percent by weight asphalt.
- Again, at 5 percent by weight of asphalt, add polyester fibers into agitator tank.
- Maintain blended asphalt temperature at least 20 degrees below flash point.
- Continuously recycle hot blended asphalt through pumps and hoses when heating kettle is in standby mode.

Application

- Sealant should be applied to dry pavement, with ambient temperatures above 40 degrees.
- Cracks should be sand cleaned and blown free of debris immediately before sealing.
- Application of sealant immediately follows cleaning of the crack.
- Sealant should be pressure applied from a wand-type applicator with “overband” nozzle.
- Seat the sealant with a steel-wheeled roller immediately after placement.
- In wider cracks, a backer rope is recommended to limit material quantities required.

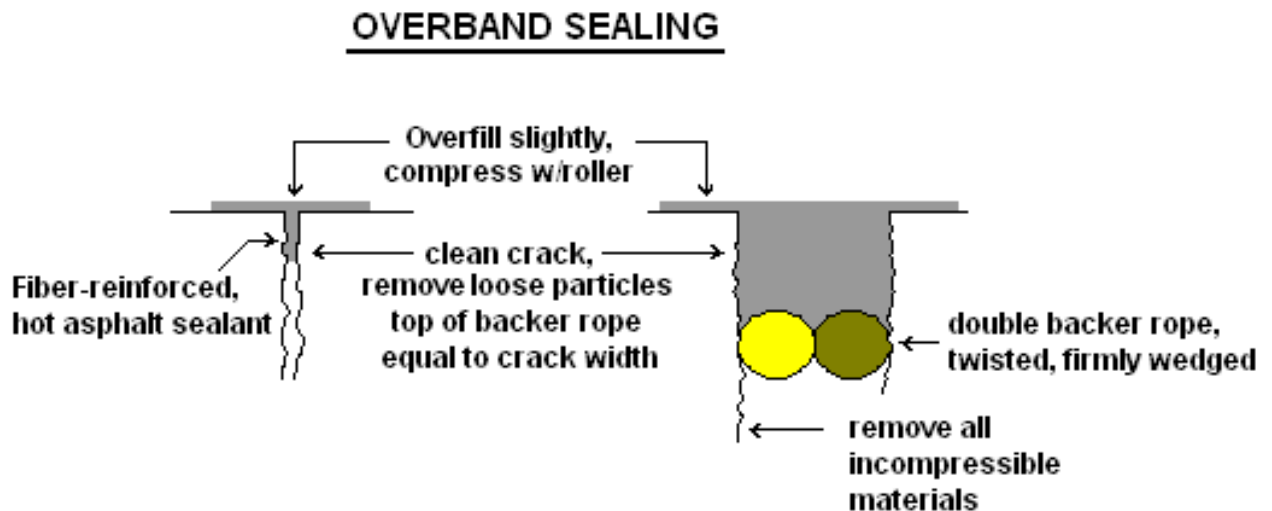

Joint Repair (portland cement)

- Rout a reservoir for the sealant ½ inch wide and 1 inch deep.
- Cracks wider than ½ inch should have reservoirs ¼ inch wider than the crack. Reservoir height above backer rope should be less than reservoir width, or as recommended by manufacturer.
- Routed cracks should be cleaned to expose fresh, vital pavement on the vertical crack edge.
- Cracks should be cleaned to remove all sand, debris, and other materials from the crack.
- Backing material should be placed into the crack.
- Apply sealant to within ¼ inch of pavement surface, following manufacturer's instructions.
- Clean the surrounding pavement area.

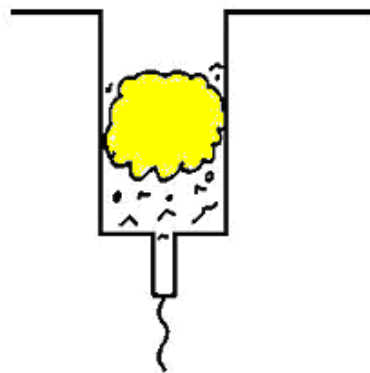

Typical failed joint sealant, w/
debris and incompressibles.

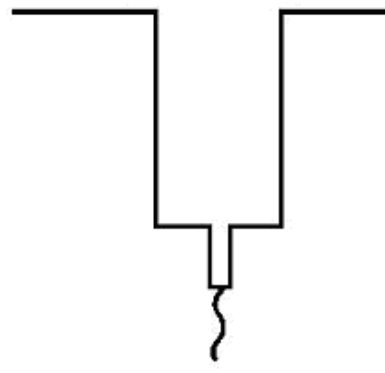

Clean joints exposing fresh,
clean concrete and stone.
Retain existing resevoir shape.

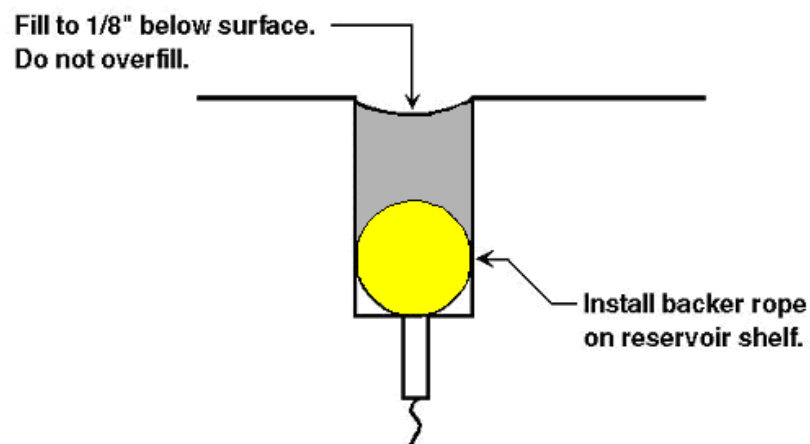

Patching (bituminous material)

- Examine distressed area and mark patch outline.
- Cut patch area with saw, no less than 3 inches deep.
- Remove enclosed pavement, leaving the vertical sawed edges undamaged.
- Clean sides and bottom and blow out with compressed air
- Paint sides and bottom with rapid curing asphalt tack coat. Prevent pooling on bottom.
- Allow tack coat to cure until it reaches a gummy consistency.
- Place hot mixed asphalt concrete and mound slightly, allowing for compaction.
- Compact with vibratory roller or plate compactor, in layers no greater than 6 inches.

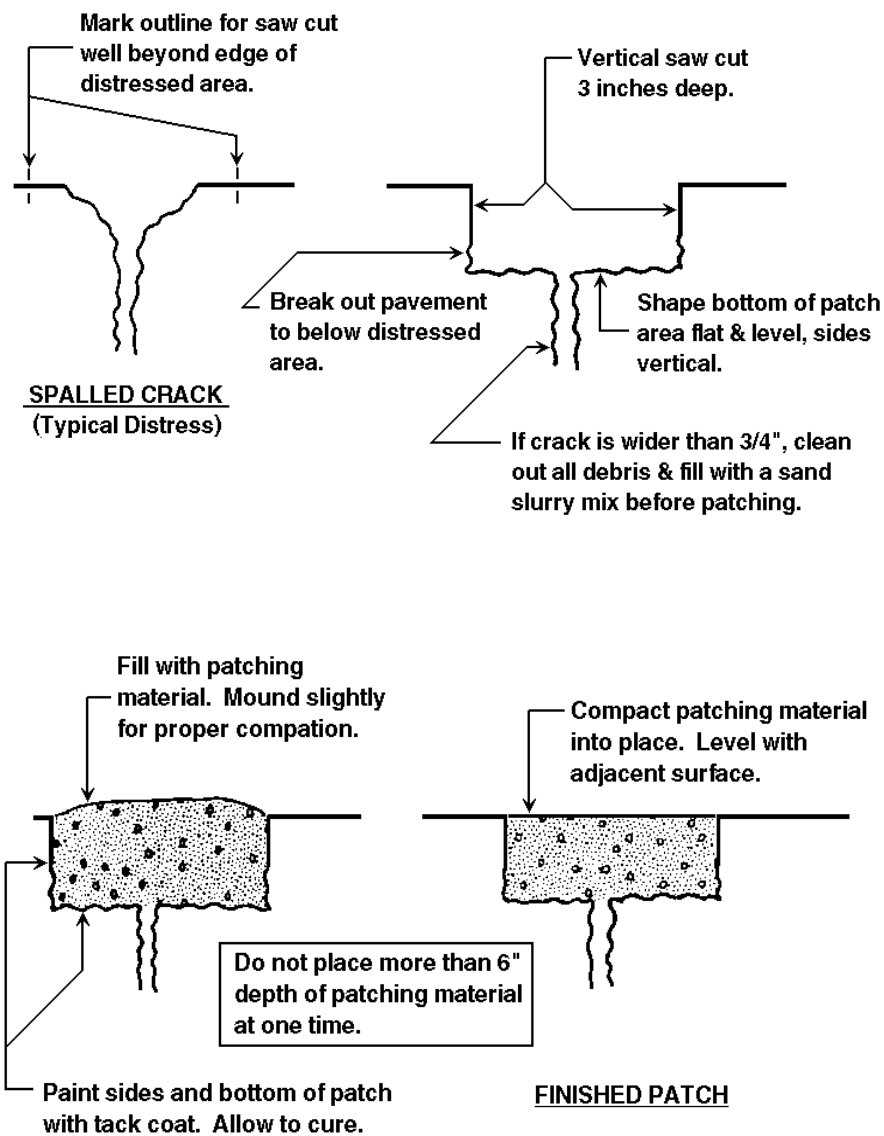

Patching (pourable materials)

Hot-applied, pourable materials generally are used to repair deficiencies larger than can be repaired by sealants, but smaller than those where traditional techniques would be required. Suggested uses for this type of repair include cracks over 2 inches wide, potholes less than 4 inches deep, as a leveling for small depressions, as a cap for settled utility cuts, and as a skin patch for areas of alligator cracking.

- Examine and mark the patch outline. Boundaries should extend to sound pavement.
- Apply patch material to clean, dry surfaces.
- A heating lance to preheat or dry existing pavement is recommended in cold or wet conditions.
- Patch material should be poured into the area to be repaired and leveled as appropriate.
- Patch edges should be sealed after application to assure good adhesion, preventing surface moisture from migrating under patch edges.

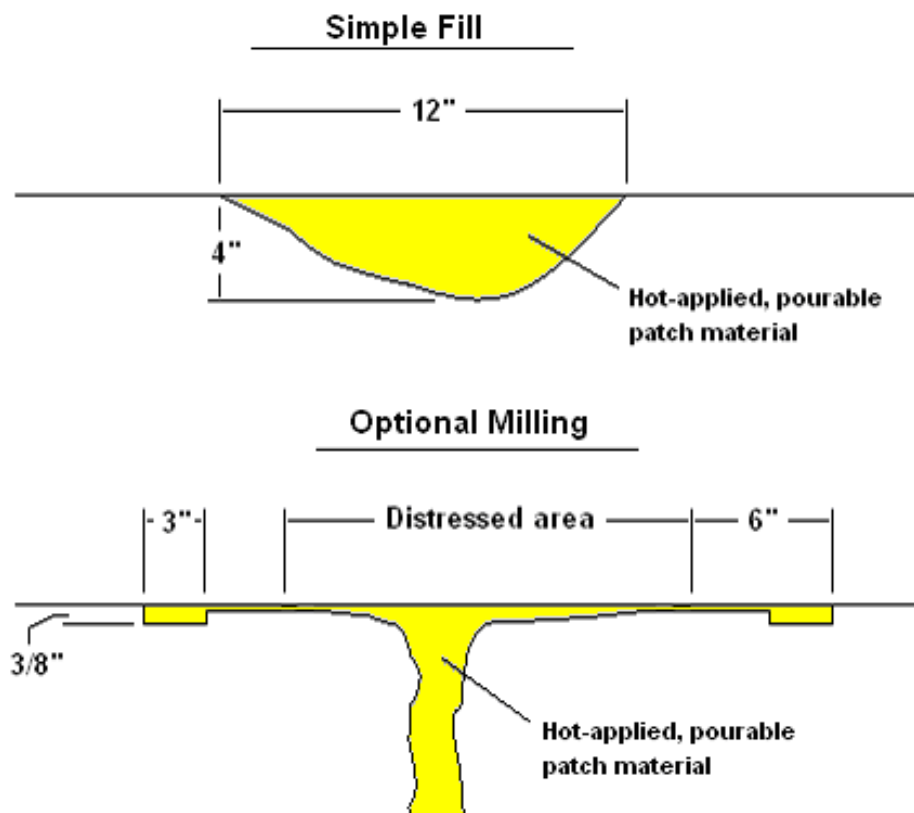

Patching (PCC)

The technique outlined here simulates a thin bonded PCC overlay. This procedure has been proven effective in service throughout the country.

- Examine and mark patch outline.
- Saw cut area to a depth of 2 inches. The enclosed area is then chipped or jack hammered to solid pavement, but not less than a 2-inch nominal depth.
- The sides and bottom are sand cleaned and air-blasted to expose vital, clean concrete.
- A 25 percent solution of muriatic acid is applied to all exposed surfaces within the patch.
- The muriatic acid solution is thoroughly flushed from the patch area with water.
- Compressed air is used to remove excess water from the area, but exposed concrete must be maintained in a moist condition.
- The sides and bottom of the area are then coated with approximately a 1/16-inch layer of cement grout applied at the consistency of paste. The grout acts as an adhesive to bond the fresh concrete to existing concrete.
- If the patch is adjacent to joints, the continuity of the joint must be maintained by placing inserts approximately the shape of the desired joint against the wall of the patch.
- Before concrete grout begins to dry, concrete is placed in the patch area and is compacted into position with hand tampers or a vibrating plate tamper.
- When the patch has been struck to the proper slope and elevation, a surface texture is applied to approximate the texture of adjacent pavement.
- Joint edges may be edged slightly to remove sharp edges. The patch should be covered with polyethylene or sprayed with a curing compound.
- Clean the surrounding pavement before concrete spillover has a chance to set up.
- The patch may be open to traffic in 72 hours.

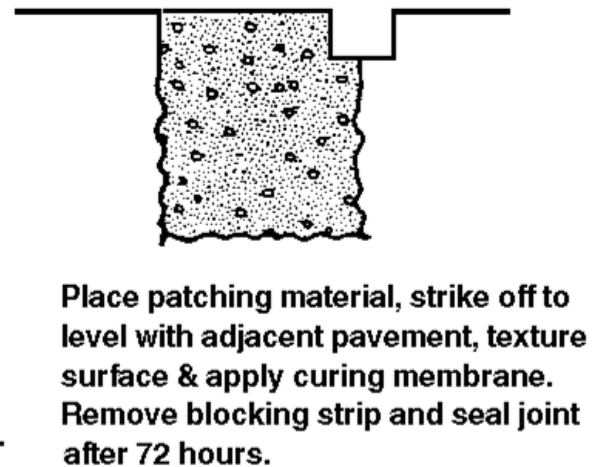
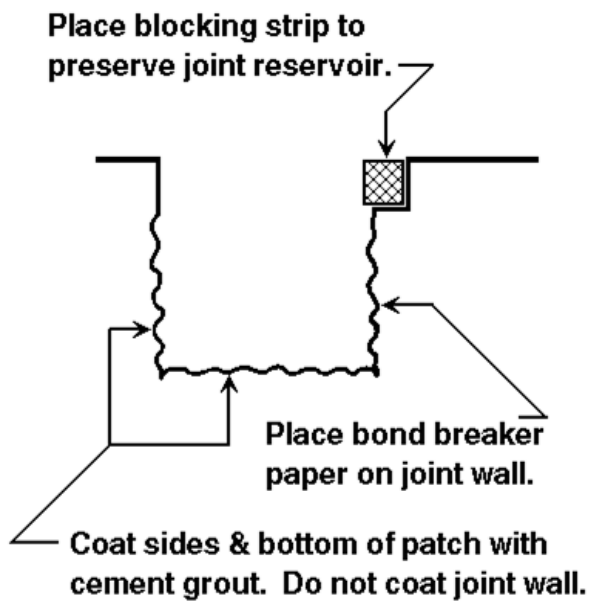
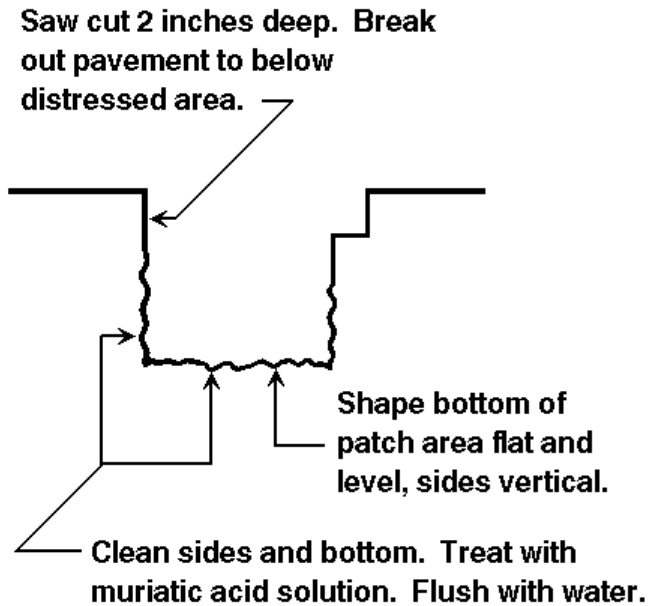
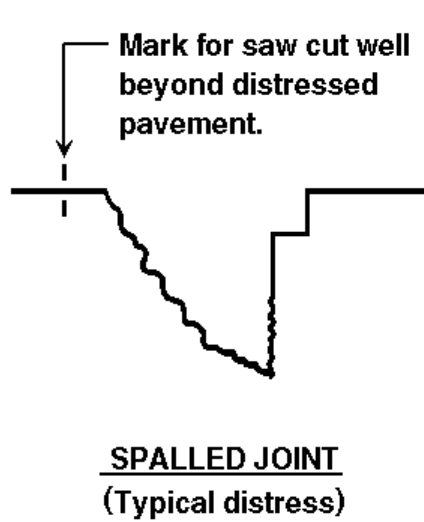

Appendix C. PCI Summary

The PCI summary provides an index of pavement conditions at the airport. The letter in the first column indicates the type of pavement, asphalt or portland cement. The last column lists the distress types found in each sample unit. The distress types are listed by a numbering code for each type of pavement, shown at the beginning of the summary.

AIRPAV						
CONDITION SURVEY SUMMARY						
AIRPORT: 417 GREENCASTLE-PUTNAM COUNTY				DATE: 12-30-2009		
"A" FLEXIBLE PAVEMENT DISTRESS CODES				"T" RIGID PAVEMENT DISTRESS CODES		
1. ALLIGATOR CRACKING 2. BLEEDING 3. BLOCK CRACKING 4. CORRUGATION 5. DEPRESSION 6. JET BLAST EROSION 7. JOINT REFL. CRACKING 8. LONG & TRANS. CRACKING 9. OIL SPILL 10. PATCHING 11. POLISHED AGGREGATE 12. RAVELLING/WEATHERING 13. RUTTING 14. SHOIVING FROM PCC SLAB 15. SLIPPAGE CRACKING 16. SWELLING				1. BLOW UP 2. CORNER BREAK 3. LTD CRACKING 4. "D" CRACKING 5. JOINT SEAL DAMAGE 6. SMALL PATCH 7. LARGE PATCH 8. POPOUTS 9. PUMPING 10. SCALING/MAP CRACKING/CRAZING 11. FAULTING 12. SHATTERED SLAB 13. SHRINKAGE CRACKING 14. JOINT SPALLING 15. CORNER SPALLING		
FEATURE:	SAMPLE UNIT:	AREA:	DATE:	SURVEYED BY:	PCI:	DISTRESSES PRESENT:
105 A	105.100	3750	8-16-09	JB	83	8 12
105 A	105.103	3500	8-16-09	JB	79	8 12
105 A	105.105	3500	8-16-09	JB	63	5 8 10 12*
105 A	105.106	3500	8-16-09	AN	79	1 8
105 A	105.109	3500	8-16-09	AN	86	8
105 A	105.112	3500	8-16-09	AN	84	8 12
MEAN FEATURE PCI = 81 BASED ON A SAMPLED AREA OF 21250 SQUARE FEET - PCI SPREAD FOR FEATURE = 22.74 DESCRIPTION: TAXIWAY A						
110 A	110.102	3500	8-16-09	JB	100	
110 A	110.106	3500	8-16-09	JB	100	
110 A	110.110	3500	8-16-09	JB	100	
110 A	110.112	3500	8-16-09	JB	100	
110 A	110.114	3500	8-16-09	JB	100	
110 A	110.118	1750	8-16-09	JB	94	8
AVERAGE FEATURE PCI = 99 BASED ON A SAMPLED AREA OF 19250 SQUARE FEET - PCI SPREAD FOR FEATURE = 6.20 DESCRIPTION: TAXIWAY A						
115 A	115.118	1750	8-16-09	JB	94	8
115 A	115.122	3500	8-16-09	JB	95	8
115 A	115.126	3500	8-16-09	JB	96	8
115 A	115.130	3500	8-16-09	JB	96	8
115 A	115.134	3500	8-16-09	JB	96	8
115 A	115.136	3500	8-16-09	JB	94	8
115 A	115.138	3500	8-16-09	JB	96	8
115 A	115.142	3500	8-16-09	AN	93	8
AVERAGE FEATURE PCI = 95 BASED ON A SAMPLED AREA OF 26250 SQUARE FEET - PCI SPREAD FOR FEATURE = 3.38 DESCRIPTION: TAXIWAY A						
210 A	210.200	3500	8-16-09	AN	94	8
210 A	210.201	3500	8-16-09	AN	94	8
210 A	210.202	1190	8-16-09	AN	86	8
AVERAGE FEATURE PCI = 91 BASED ON A SAMPLED AREA OF 8190 SQUARE FEET - PCI SPREAD FOR FEATURE = 7.93 DESCRIPTION: CONNECTOR TAXIWAY B						

Sample units marked with an asterisk (*) are additional sample units. Additional sample units do not represent the typical condition of surrounding sample units in the pavement features.

The PCI summary provides a quick overview of the pavement condition and consistency. Are the distress types similar? Do the individual sample units have consistent PCI ratings? Answering these questions is a start to understanding your dynamic pavement system.

CONDITION SURVEY SUMMARY

AIRPORT: 8A4 INDIANAPOLIS DOWNTOWN HELIPORT

DATE: 01-16-2015

"A" FLEXIBLE PAVEMENT DISTRESS CODES

1. ALLIGATOR CRACKING
2. BLEEDING
3. BLOCK CRACKING
4. CORRUGATION
5. DEPRESSION
6. JET BLAST EROSION
7. JOINT REFL. CRACKING
8. LONG. & TRANS. CRACKING
9. OIL SPILL
10. PATCHING
11. POLISHED AGGREGATE
12. RAVELLING
13. RUTTING
14. SHOVING FROM PCC SLAB
15. SLIPPAGE CRACKING
16. SWELLING
17. WEATHERING

"P" RIGID PAVEMENT DISTRESS CODES

1. BLOW UP
2. CORNER BREAK
3. LTD CRACKING
4. "D" CRACKING
5. JOINT SEAL DAMAGE
6. SMALL PATCH
7. LARGE PATCH
8. POPOUTS
9. PUMPING
10. SCALING/MAP CRACKING/CRAZING
11. FAULTING
12. SHATTERED SLAB
13. SHRINKAGE CRACKING
14. JOINT SPALLING
15. CORNER SPALLING
16. ALKALI SILICA REACTION

FEATURE:	SAMPLE UNIT:	AREA:	DATE:	SURVEYED BY:	PCI:	DISTRESSES PRESENT:
----------	--------------	-------	-------	--------------	------	---------------------

3005 P	3005.200	3282	10-24-14	EOJ	98	6 7
--------	----------	------	----------	-----	----	-----

AVERAGE FEATURE PCI = 98
BASED ON A SAMPLED AREA OF 3282 SQUARE FEET - PCI SPREAD FOR FEATURE = 0.00
DESCRIPTION: RAMP

3010 A	3010.100	2862	10-24-14	EOJ	62	8 10 12
--------	----------	------	----------	-----	----	---------

AVERAGE FEATURE PCI = 62
BASED ON A SAMPLED AREA OF 2862 SQUARE FEET - PCI SPREAD FOR FEATURE = 0.00
DESCRIPTION: RAMP

3015 P	3015.103	2160	10-24-14	ABN	100	
3015 P	3015.202	2040	10-24-14	ABN	100	
3015 P	3015.303	2160	10-24-14	ABN	100	
3015 P	3015.306	2160	10-24-14	ABN	100	
3015 P	3015.308	2160	10-24-14	ABN	100	
3015 P	3015.309	2160	10-24-14	ABN	100	
3015 P	3015.402	2160	10-24-14	ABN	100	
3015 P	3015.405	2160	10-24-14	ABN	99	6
3015 P	3015.407	2160	10-24-14	ABN	100	
3015 P	3015.503	1440	10-24-14	ABN	95	7
3015 P	3015.507	1080	10-24-14	ABN	88	2 6

AVERAGE FEATURE PCI = 98
BASED ON A SAMPLED AREA OF 21840 SQUARE FEET - PCI SPREAD FOR FEATURE = 12.15
DESCRIPTION: RAMP

3020 P	3020.300	2075	10-24-14	EOJ	99	6
3020 P	3020.301	3720	10-24-14	ABN	100	

AVERAGE FEATURE PCI = 100
BASED ON A SAMPLED AREA OF 5795 SQUARE FEET - PCI SPREAD FOR FEATURE = 0.80
DESCRIPTION: RAMP

TOTAL NUMBER OF INSPECTED FEATURES = 4
TOTAL NUMBER OF INSPECTED SAMPLE UNITS = 15

TOTAL AREA OF INSPECTED PAVEMENT = 33,779 S.F.

* INDICATES "ADDITIONAL" SAMPLE UNITS.

Appendix D. Distress Identification

This chapter describes pavement distress types commonly identified during airport PCI inspections.

Rigid Pavement Distress

Longitudinal, Transverse & Diagonal Cracking

LTD cracking is often a result of load or temperature deformations. External loads cause flexure. Temperature changes can cause curling. When any of these stresses exceed the slab strength, cracking occurs.

LTD cracking is recorded at low, medium, or high severity, depending on the width of crack opening and degree of deterioration.

At low severity, a crack is less than 1/8 inch wide with little spalling, and no corrective action is indicated. At medium severity, LTD cracks can be up to 1 inch wide with moderate spalling and should be repaired using procedures similar to joint sealing. At high severity, cracks exceed 1 inch in width and may be severely spalled. High-severity LTD cracking is evidence of serious load failure, and correction may require patching or slab replacement. If distress occurs in several adjacent slabs at medium or high severity, major rehabilitation of that area is indicated.

A slab divided into four or more pieces is said to be “divided” or “shattered.” Shattered slab is a separate distress category and indicates a significant structural failure. A shattered slab has lost its ability to distribute loads. Shattered slabs are rated in three severities, but the recommended action in any case is slab replacement.



Shrinkage Cracking

Shrinkage cracks are small, non-working cracks visible at the pavement surface but not penetrating the full depth of concrete. Shrinkage cracks most commonly occur shortly after construction due to concrete shrinkage during the curing process.

Shrinkage cracks are usually so small that they are not visible until staining or loss of material at crack edges begins to take place. Shrinkage cracks do not represent structural weakness, and no corrective action is prescribed.



Durability Cracking

Durability cracking (D-cracking) is caused by environmental factors, the most common being freeze/thaw. D-cracking usually appears as either a pattern of hairline cracks running parallel to a joint or crack, or in a corner, where water tends to collect. D-cracking eventually leads to disintegration of the pavement, creating foreign object damage (FOD) potential.

At low severity, D-cracking is evident, but no disintegration has occurred. Medium severity is evident over a significant area of the slab, and some disintegration and FOD potential exist. High-severity D-cracking is evidenced by extensive cracking with loose and missing pieces and significant FOD potential.



Joint Spall and Corner Spall

Spalls at slab joints and corners are caused by excessive internal stress in the pavement. Spalls occur when these stresses exceed the shear strength of the concrete.

Spalling usually results from thermal expansion during hot weather when slabs push and expand against one another. If the joints are filled with incompressible material, such as sand, stresses can become severe, causing spalls. Spalling can be reduced significantly by maintenance of joint sealant.

Spall repair requires patching. The extent and severity of spalling suggests the appropriate action. At low severity, spalled concrete remains securely in place in the slab. A low-severity spall should be monitored closely for further deterioration and should be patched when spalled particles become loose, or during the next scheduled patching activity. Medium- and high-severity spalls should be repaired immediately to prevent FOD. If the pavement can be restored to serviceable condition, spalls should be patched for long-term service. If the pavement is beyond repair, temporary patching should be considered to control FOD.



Patches, Large and Small

Large and small patches, by PCI inspection criteria, are distress conditions. Patches indicate deterioration and aging of pavement that contributes to shortened service life. However, patching also indicates that pavement is being maintained.

A patch that is performing well and shows no outward distress is recorded at low severity, and no corrective action is required. Medium-severity patches are serviceable but are beginning to deteriorate. Maintenance or replacement is indicated. At high severity, replacement is indicated.

By definition, small patches are smaller than 5 square feet in surface area, and they usually result from spall repair at slab joints and corners.

Large patches also may be the result of spall repair, but they often indicate more serious deficiencies, such as corner breaks or other full-depth failure smaller than panel size.



Joint Seal Damage

When joint sealant is in perfect condition (no damage), there is no distress.

At low severity, at least 10 percent of the sealant is debonded but still in contact with the joint edges. Medium-severity joint seal damage is recorded when at least 10 percent of the sealant has visible gaps smaller than 1/8 inch and is an indicator that replacement should be programmed as soon as is practical. In the meantime, aggressive inspection and sustaining maintenance is recommended to minimize subsurface damage from moisture penetration. At high severity, visible gaps exceed 1/8 inch, and the amount and degree of joint seal damage typically requires complete removal and replacement of the existing sealant.

On serviceable pavement, deteriorated joint sealant should be repaired or replaced to preserve pavement and subgrade integrity and prolong service life. The issue is not so clear-cut with unserviceable pavement. Pavement that can be restored to serviceable condition by maintenance activities such as patching and joint seal repair, or by slab replacement, should be so maintained as long as the process is cost-effective. However, when age and condition preclude economical return to serviceable condition by such means, joint seal repair would no longer be cost-effective and should be suspended except for an interim maintenance program to control FOD potential.



Flexible Pavement Distress

Longitudinal & Trans. Cracking

L&T cracks are caused by age, construction, and subsurface conditions. Age-related cracking occurs as oxidizing pavement loses components to the atmosphere and becomes more brittle. Consistent application of seal coats can help to prevent age-related cracks.

Construction-related cracking often develops along paving joints. Ensuring that joints are made when both sides are still hot, and near the same temperature, is one of the best ways to mitigate this potential problem.

Seasonal movement caused by changes in subsurface moisture or temperature differences also can cause pavement cracking. Asphalt pavement placed over a PCC pavement or cement stabilized base course may evidence reflective cracking from the underlying material. Wheel loads do not cause L&T cracks, although traffic may worsen their condition.

Low-severity L&T cracks are less than ¼ inch wide, or if sealed with suitable filler material in satisfactory condition can be any width less than 3 inches, if they are not spalled. Maintenance usually is not indicated for low-severity cracking. Moderately spalled cracks and cracks wider than ¼ inch which are not satisfactorily sealed are at medium severity. Medium-severity cracks should be sealed with a high-quality crack filling material. Severely spalled cracks and cracks wider than 3 inches are at high severity. High-severity L&T cracks normally require patching.



Alligator Cracking

Alligator cracks are a series of interconnected load-related cracks caused by fatigue of the asphalt surface. Alligator cracking is a significant structural distress and develops only in places subject to traffic loads. These cracks typically initiate at the bottom of the asphalt layer and propagate upward. Once a fatigue crack is visible at the surface, significant damage has already occurred.

At low severity, alligator cracks are evidenced by a series of parallel hairline cracks (usually in a wheel path). Medium-severity alligator cracking is a well-defined pattern of interconnected cracks, and some spalling may be present. High-severity alligator cracks have lost aggregate interlock between adjacent pieces, and the cracks may be severely spalled with FOD potential. Most likely, the pieces will move freely under traffic.

Alligator cracking is a serious structural failure that cannot be repaired with sealant. The proper repair is patching.



Raveling/Weathering

Raveling and weathering are the wearing away of the pavement surface. Failure can be caused by the dislodging of aggregate particles or the loss of asphalt binder. These distresses are usually evident over large areas and may indicate that the asphalt binder has hardened significantly.

Raveling is the loss of coarse aggregate, weathering is the loss of fine aggregate or binder.

Raveling: At low severity, 5 to 20 coarse aggregate particles are missing per square yard. Medium severity is defined by 20 to 40 missing coarse aggregate particles per square yard. At high severity, more than 40 coarse aggregate particles are missing per square yard, and the top layer of aggregate has eroded away.

Weathering: At low severity, edges of coarse aggregate are exposed less than 1 mm. At medium severity, loss of fine aggregate is noticeable and edges of coarse aggregate are exposed up to 6 mm (1/4 inch). High severity weathering has edges of coarse aggregate exposed > 6 mm, with considerable loss of fine aggregate matrix and potential for loss of coarse aggregate.



Rutting

Ruts are localized areas of pavement having elevations lower than the surrounding sections.

Rutting is due to base and subgrade consolidation caused by excessive wheel loads or poor compaction. Ruts indicate structural failure and can cause hydroplaning.

At low severity, ruts have an average depth of ¼ to ½ inches. At medium severity, ruts have an average depth of ½ to 1 inch. At high severity, ruts have an average depth greater than 1 inch. Patching is the appropriate repair for ruts.



Appendix E. Feature Analysis

Pavement Performance Models

Projected performance is determined by relating current pavement condition to expected pavement condition. Projected performance varies based on pavement type. There are four pavement types in Indiana: AC, PCC, ACC, and APC. Each pavement type has a unique deterioration curve, created by plotting all data for that group as PCI vs. age and then finding a performance curve to best fit the data. These curves represent the historic performance of pavement in the group and become the baseline for future projections. The baseline curves are modeled with a third order polynomial equation as shown below.

$$PCI = X(\text{Age})^3 + Y(\text{Age})^2 + Z(\text{Age}) + C$$

Current Condition (rotating the curves)

Starting with the baseline curve for comparison, current pavement condition is plotted, and the baseline curve is rotated to meet the current condition. The rotated curve provides the starting point for projecting the future pavement condition.

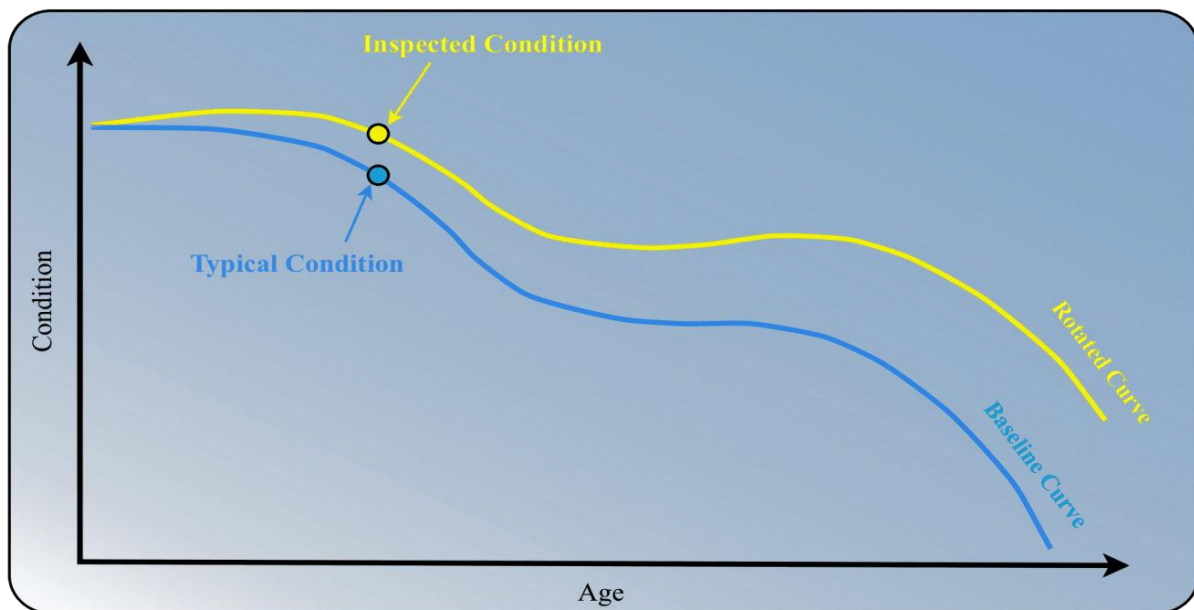

Advanced Analysis (accounting for distress)

Some types of pavement distress have a greater impact on pavement deterioration than others. Rutting and alligator (fatigue) cracking are major structural failures and can lead to rapid pavement deterioration. Other distress types, like L&T cracking, develop slowly over time and typically do not cause a significant deviation from the baseline curve.

After current condition is accounted for with the curve rotation, pavement distress is addressed in the advanced analysis by compressing or expanding the baseline curve to account for the expected rate of pavement deterioration.

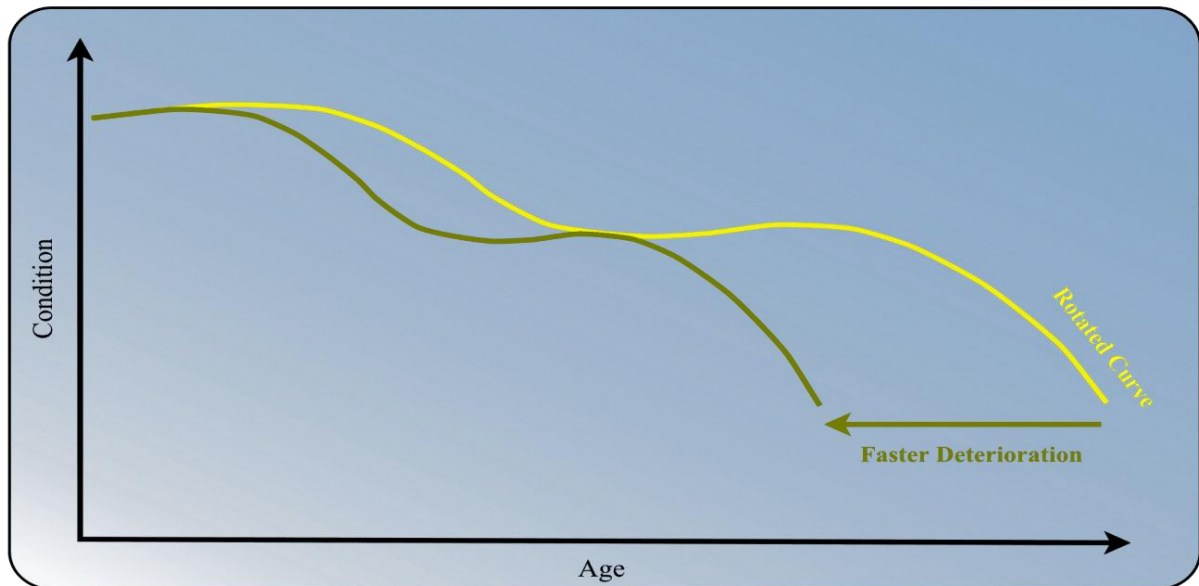

Projected PCI (near term vs. longer term)

Projecting pavement condition with advanced analysis is a combination of rotating, expanding, and contracting the baseline curves. This projection method provides good short-term results for all pavement sections and fair long-term projections on pavement sections with conditions near the baseline model. The long-term accuracy of outlier data is discussed on the following page.

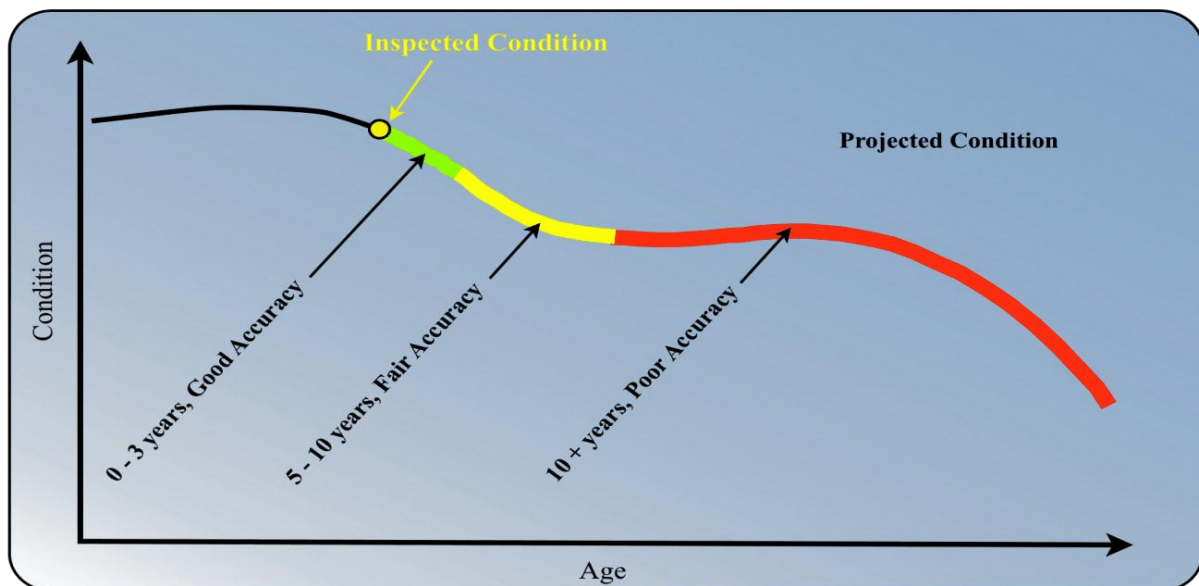

Projected PCI (why some features have unexpected projections)

Long-term PCI projections can be very useful for planning purposes. However, projections in excess of 10 years are well beyond the intended scope of the PCI procedure. FAA Advisory Circular 150/5380-6B establishes a maximum 3-year interval between detailed PCI surveys.

Curve rotation, expansion, and contraction are performed to produce the best possible accuracy of future pavement condition over the next 3 to 5 years. This methodology can overemphasize certain performance trends in the long term. This is especially true for outlier data, such as pavement features that are performing much better or worse than is typical.

The curve below shows an example of a performance trend being overemphasized in the long-term projection. Because the pavement feature is performing much better than the baseline curve, the long-term projection shows the pavement lasting an additional 30+ years before reaching the MSL. Rotation of the curve to provide the most accurate projection over 3 to 5 years has resulted in a long-term projection that is likely unrealistic.

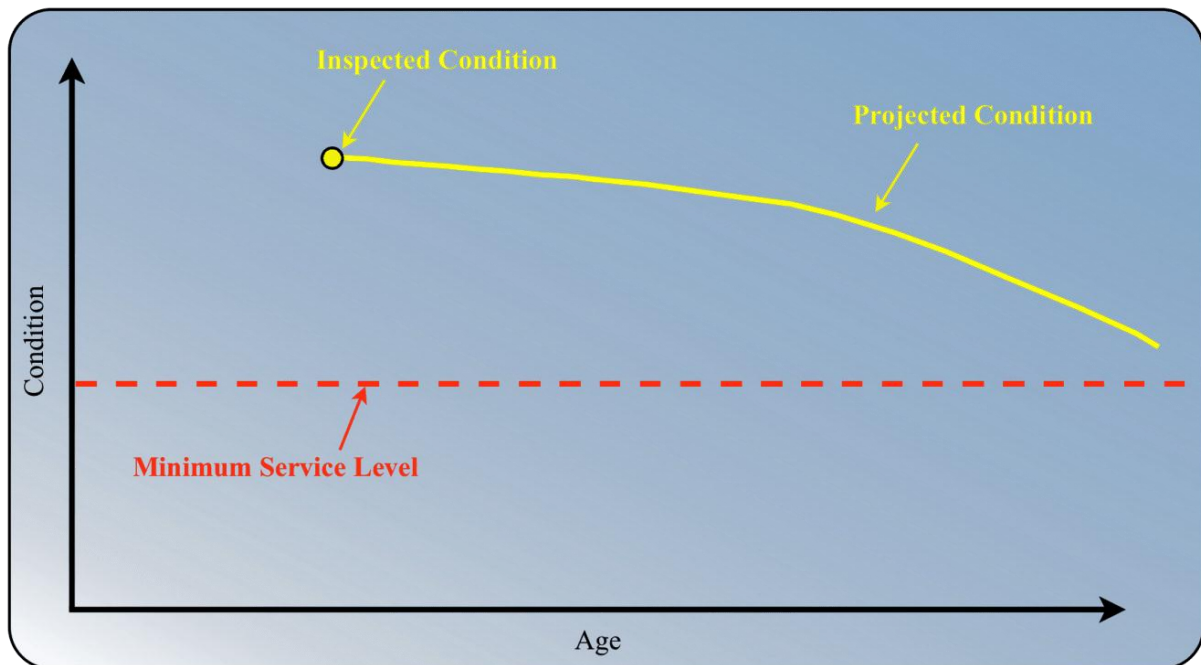

When long-term projections such as this are encountered, airport managers should not rely on projections in excess of 10 years. Managers can be confident that the pavement is performing much better than average and will not require rehabilitation within the current 5-year CIP planning window. As new distress develops over time, future PCI surveys will determine the ideal timing for rehabilitation.

Feature Analysis

As part of the PCI evaluation, a detailed analysis is presented for each airside pavement feature using the two-page format depicted below.

Page 1

The first page of the analysis is a feature summary. Located near the top left-hand corner is the feature number and pavement description. Construction history and inspector comments are listed below, along with a photo of the pavement section if available. Distress totals recorded during the PCI survey are listed next, and an approximation of the cause of the pavement deterioration is shown at the bottom. If the pavement is projected to fall below the desired MSL during the next 12 years, the analysis year will be shown along with the optimum year for pavement rehabilitation.

AIRPAV

AIRPORT: BLOOMINGTON/MONROE COUNTY

AIRPAV FEATURE ANALYSIS PROGRAM OUTPUT

FEATURE: 5007

ANALYSIS YEAR: 2011 **OPTIMIZED FOR: 2019**

PAVEMENT TYPE: AC

FEATURE AREA: 1,278,750

INSPECTED AREA: 40,000

MINIMUM SERVICE LEVEL: .65

DESCRIPTION: RUNWAY 17-35 KEEL

INSPECTION DATE: 8-11-11

FEATURE'S HIGH PCI: 72

FEATURE'S LOW PCI: 59

AVERAGE PCI: 69 GOOD

ESTIMATED PCI IS: 65 in 2019

COMMENTS/HISTORY FOR FEATURE 5007, RUNWAY 17-35 KEEL

1989: 4" P401 / 5" P401 / 13" P209
+
*.

DISTRESS TYPE	SEVERITY	MEASURED QUANTITY	ESTIMATED TOTAL QUANTITY	UNITS	PERCENTAGE OF AIR DISTRESS
ALLIGATOR CRACKING	LOW	66	2,109	S.F.	8.3
LONG & TRANS. CRACK	MED	995	31,868	L.F.	38.4
LONG & TRANS. CRACK	LOW	2,824	90,279	L.F.	34.8
RAVELING/WEATHERING	LOW	9,450	302,104	S.F.	26.3

BASIC DISTRESS CAUSES

APPROXIMATE AMOUNT OF DISTRESS RELATED TO LOAD ON THE PAVEMENT IS: 8 %

APPROXIMATE AMOUNT OF DISTRESS RELATED TO MATERIALS PROBLEMS IN THE FEATURE IS: 52 %

APPROXIMATE AMOUNT OF DISTRESS RELATED TO AGE OF PAVEMENT AND TRAFFIC REPETITIONS IS: 39 %

PAGE 1

Description & Feature # →

Optimized Rehab Year →

Construction History ←

Distress Totals ←

The second page is a graphic analysis of pavement deterioration. Pavement deterioration is forecast based on historic deterioration of similar Indiana pavement types. Remaining life is projected by stretching and rotating the baseline curves to fit the current condition determined from the PCI survey.

When pavement condition drops below the desired MSL, the software selects rehabilitation actions that address the cause of the pavement failure while restoring the pavement to a condition above the MSL. A NO ACTION recommendation indicates that the feature is expected to remain serviceable during the 12-year forecasting period without major repairs. NO ACTION recommendations do not diminish the need for regular maintenance.

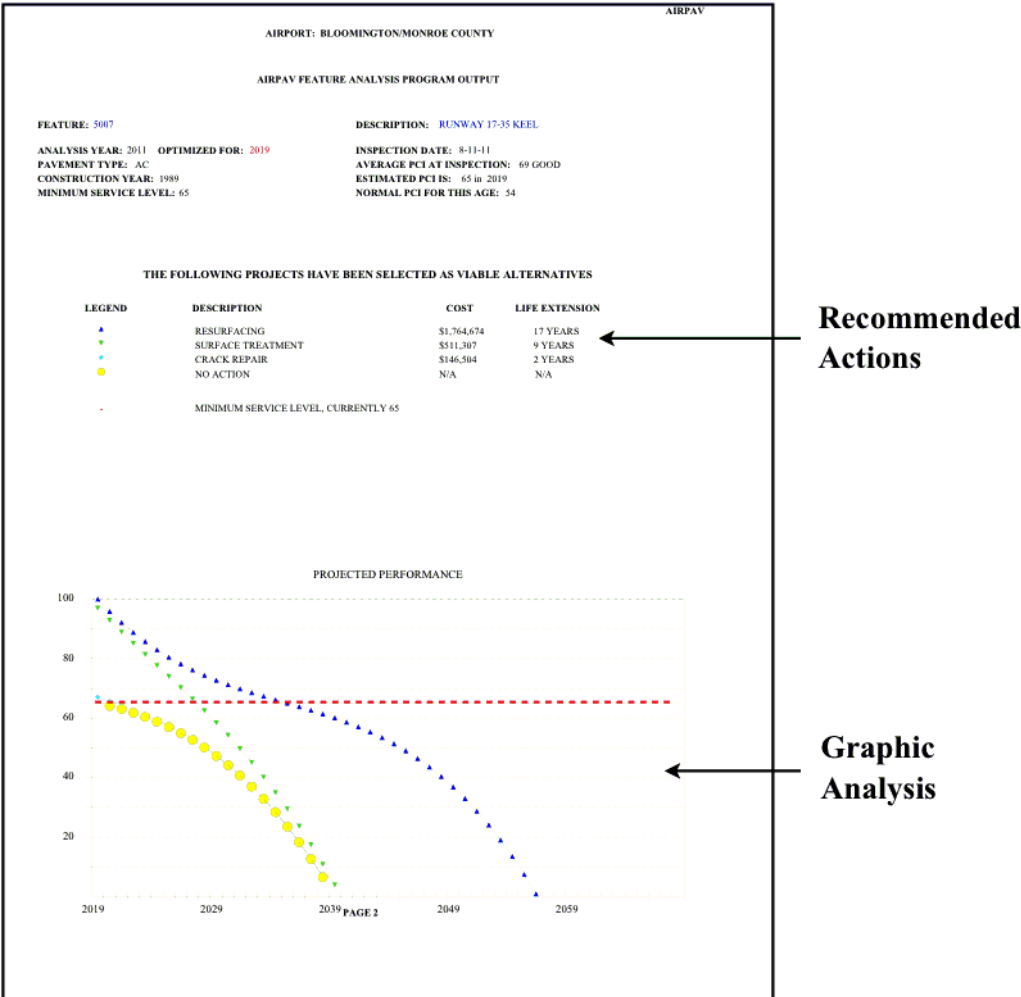

AIRPORT: INDIANAPOLIS DOWNTOWN HELIPORT

AIRPAV FEATURE ANALYSIS PROGRAM OUTPUT

FEATURE: 3005

DESCRIPTION: RAMP

ANALYSIS YEAR: 2015

INSPECTION DATE: 10-24-14

PAVEMENT TYPE: PCC

FEATURE'S HIGH PCI: 98

FEATURE AREA: 3,282

FEATURE'S LOW PCI: 98

INSPECTED AREA: 3,282

AVERAGE PCI: 98 GOOD

MINIMUM SERVICE LEVEL: 55

ESTIMATED PCI IS: 96 in 2015

COMMENTS/HISTORY FOR FEATURE 3005, RAMP

1985 UNKNOWN P501 SECTION

*
*
*

DISTRESS QUANTITIES FOR FEATURE 3005

DISTRESS TYPE	SEVERITY	MEASURED QUANTITY	ESTIMATED TOTAL QUANTITY	UNITS	PERCENTAGE OF All DISTRESS
PATCH<5 SF	LOW	2	2	SLABS	29.8
PATCH>5 SF/UTIL.CUT	LOW	1	1	SLABS	70.1

BASIC DISTRESS CAUSES

APPROXIMATE AMOUNT OF DISTRESS RELATED TO LOAD ON THE PAVEMENT IS:	23 %
APPROXIMATE AMOUNT OF DISTRESS RELATED TO MATERIALS PROBLEMS IN THE FEATURE IS:	43 %
APPROXIMATE AMOUNT OF DISTRESS RELATED TO AGE OF PAVEMENT AND TRAFFIC REPETITIONS IS:	33 %



AIRPORT: INDIANAPOLIS DOWNTOWN HELIPORT

AIRPAV FEATURE ANALYSIS PROGRAM OUTPUT

FEATURE: 3005

DESCRIPTION: RAMP

ANALYSIS YEAR: 2015

INSPECTION DATE: 10-24-14

PAVEMENT TYPE: PCC

AVERAGE PCI AT INSPECTION: 98 GOOD

CONSTRUCTION YEAR: 1985

ESTIMATED PCI IS: 96 in 2015

MINIMUM SERVICE LEVEL: 55

NORMAL PCI FOR THIS AGE: 55

THE FOLLOWING PROJECTS HAVE BEEN SELECTED AS VIABLE ALTERNATIVES

LEGEND	DESCRIPTION	COST	LIFE EXTENSION
●	NO ACTION	N/A	N/A
-	MINIMUM SERVICE LEVEL, CURRENTLY 55		

PROJECTED PERFORMANCE

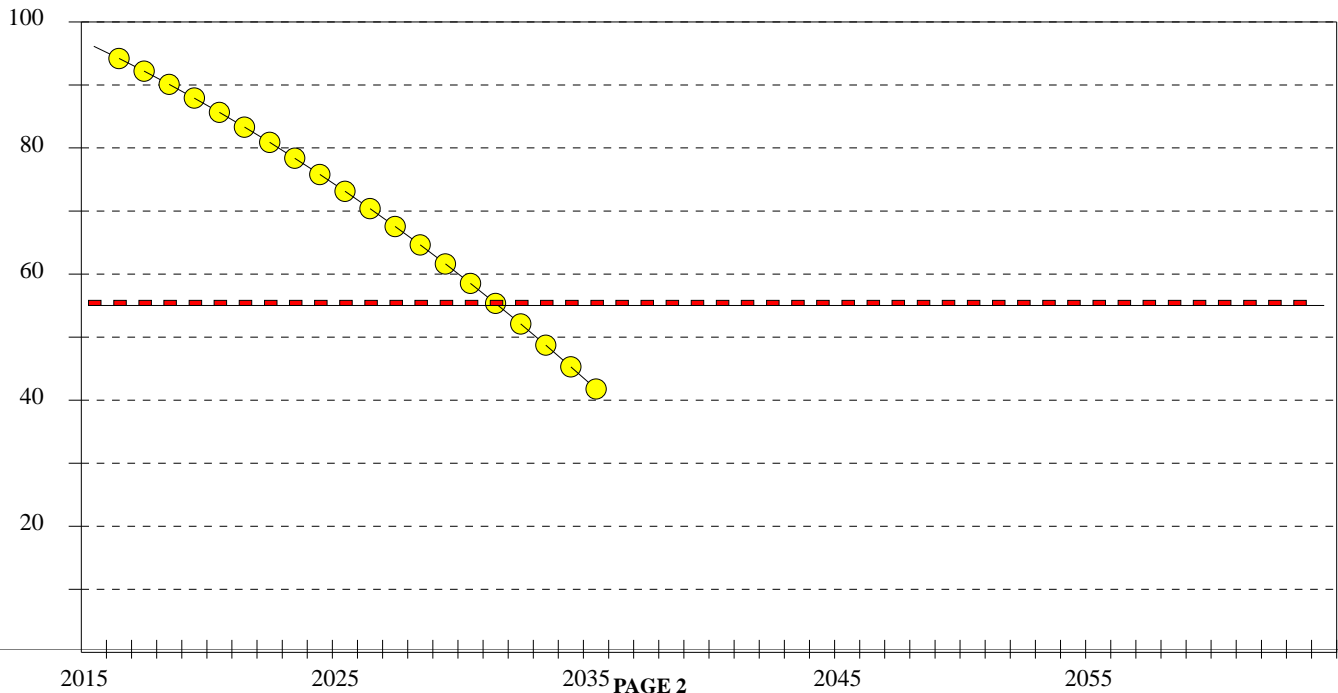

AIRPORT: INDIANAPOLIS DOWNTOWN HELIPORT

AIRPAV FEATURE ANALYSIS PROGRAM OUTPUT

FEATURE: 3010

DESCRIPTION: RAMP

ANALYSIS YEAR: 2015 OPTIMIZED FOR: 2017

INSPECTION DATE: 10-24-14

PAVEMENT TYPE: AC

FEATURE'S HIGH PCI: 62

FEATURE AREA: 2,862

FEATURE'S LOW PCI: 62

INSPECTED AREA: 2,862

AVERAGE PCI: 62 FAIR

MINIMUM SERVICE LEVEL: 55

ESTIMATED PCI IS: 53 in 2017

COMMENTS/HISTORY FOR FEATURE 3010, RAMP

1985 UNKNOWN P401 SECTION

*
*
*

DISTRESS QUANTITIES FOR FEATURE 3010

DISTRESS TYPE	SEVERITY	MEASURED QUANTITY	ESTIMATED TOTAL QUANTITY	UNITS	PERCENTAGE OF ALL DISTRESS
LONG.& TRANS. CRACK	MED	21	21	L.F.	20.9
LONG.& TRANS. CRACK	LOW	352	352	L.F.	58.4
PATCH & UTILITY CUT	LOW	9	9	S.F.	4.6
RAVELING	HIGH	3	3	S.F.	15.9

BASIC DISTRESS CAUSES

APPROXIMATE AMOUNT OF DISTRESS RELATED TO LOAD ON THE PAVEMENT IS:	3 %
APPROXIMATE AMOUNT OF DISTRESS RELATED TO MATERIALS PROBLEMS IN THE FEATURE IS:	60 %
APPROXIMATE AMOUNT OF DISTRESS RELATED TO AGE OF PAVEMENT AND TRAFFIC REPETITIONS IS:	37 %



AIRPORT: INDIANAPOLIS DOWNTOWN HELIPORT

AIRPAV FEATURE ANALYSIS PROGRAM OUTPUT

FEATURE: 3010

DESCRIPTION: RAMP

ANALYSIS YEAR: 2015 OPTIMIZED FOR: 2017

INSPECTION DATE: 10-24-14

PAVEMENT TYPE: AC

AVERAGE PCI AT INSPECTION: 62 FAIR

CONSTRUCTION YEAR: 1985

ESTIMATED PCI IS: 53 in 2017

MINIMUM SERVICE LEVEL: 55

NORMAL PCI FOR THIS AGE: 33

THE FOLLOWING PROJECTS HAVE BEEN SELECTED AS VIABLE ALTERNATIVES

LEGEND	DESCRIPTION	COST	LIFE EXTENSION
▲	RESURFACING	\$4,121	23 YEARS
▼	SURFACE TREATMENT	\$1,142	6 YEARS
◆	CRACK REPAIR	\$462	1 YEAR
●	NO ACTION	N/A	N/A
-	MINIMUM SERVICE LEVEL, CURRENTLY 55		

PROJECTED PERFORMANCE

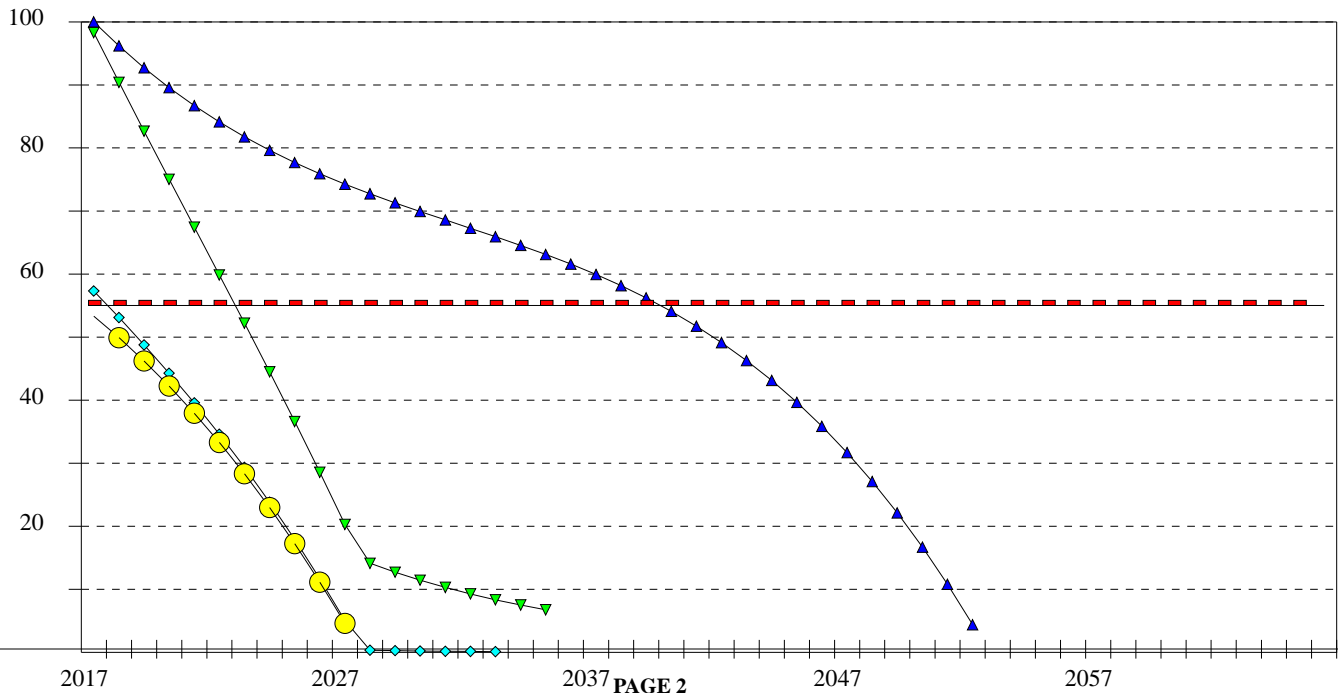

AIRPORT: INDIANAPOLIS DOWNTOWN HELIPORT

AIRPAV FEATURE ANALYSIS PROGRAM OUTPUT

FEATURE: 3015

DESCRIPTION: RAMP

ANALYSIS YEAR: 2015

INSPECTION DATE: 10-24-14

PAVEMENT TYPE: PCC

FEATURE'S HIGH PCI: 100

FEATURE AREA: 66,060

FEATURE'S LOW PCI: 88

INSPECTED AREA: 21,840

AVERAGE PCI: 98 GOOD

MINIMUM SERVICE LEVEL: 55

ESTIMATED PCI IS: 96 in 2015

COMMENTS/HISTORY FOR FEATURE 3015, RAMP

1985 UNKNOWN P501 SECTION

*
*
*

DISTRESS QUANTITIES FOR FEATURE 3015

DISTRESS TYPE	SEVERITY	MEASURED QUANTITY	ESTIMATED TOTAL QUANTITY	UNITS	PERCENTAGE OF All DISTRESS
CORNER BREAK	LOW	1	3	SLABS	49.7
PATCH<5 SF	LOW	4	12	SLABS	24.5
PATCH>5 SF/UTIL.CUT	LOW	1	3	SLABS	25.7

BASIC DISTRESS CAUSES

APPROXIMATE AMOUNT OF DISTRESS RELATED TO LOAD ON THE PAVEMENT IS:	42 %
APPROXIMATE AMOUNT OF DISTRESS RELATED TO MATERIALS PROBLEMS IN THE FEATURE IS:	42 %
APPROXIMATE AMOUNT OF DISTRESS RELATED TO AGE OF PAVEMENT AND TRAFFIC REPETITIONS IS:	17 %



AIRPORT: INDIANAPOLIS DOWNTOWN HELIPORT

AIRPAV FEATURE ANALYSIS PROGRAM OUTPUT

FEATURE: 3015

DESCRIPTION: RAMP

ANALYSIS YEAR: 2015

INSPECTION DATE: 10-24-14

PAVEMENT TYPE: PCC

AVERAGE PCI AT INSPECTION: 98 GOOD

CONSTRUCTION YEAR: 1985

ESTIMATED PCI IS: 96 in 2015

MINIMUM SERVICE LEVEL: 55

NORMAL PCI FOR THIS AGE: 55

THE FOLLOWING PROJECTS HAVE BEEN SELECTED AS VIABLE ALTERNATIVES

LEGEND	DESCRIPTION	COST	LIFE EXTENSION
●	NO ACTION	N/A	N/A
-	MINIMUM SERVICE LEVEL, CURRENTLY 55		

PROJECTED PERFORMANCE

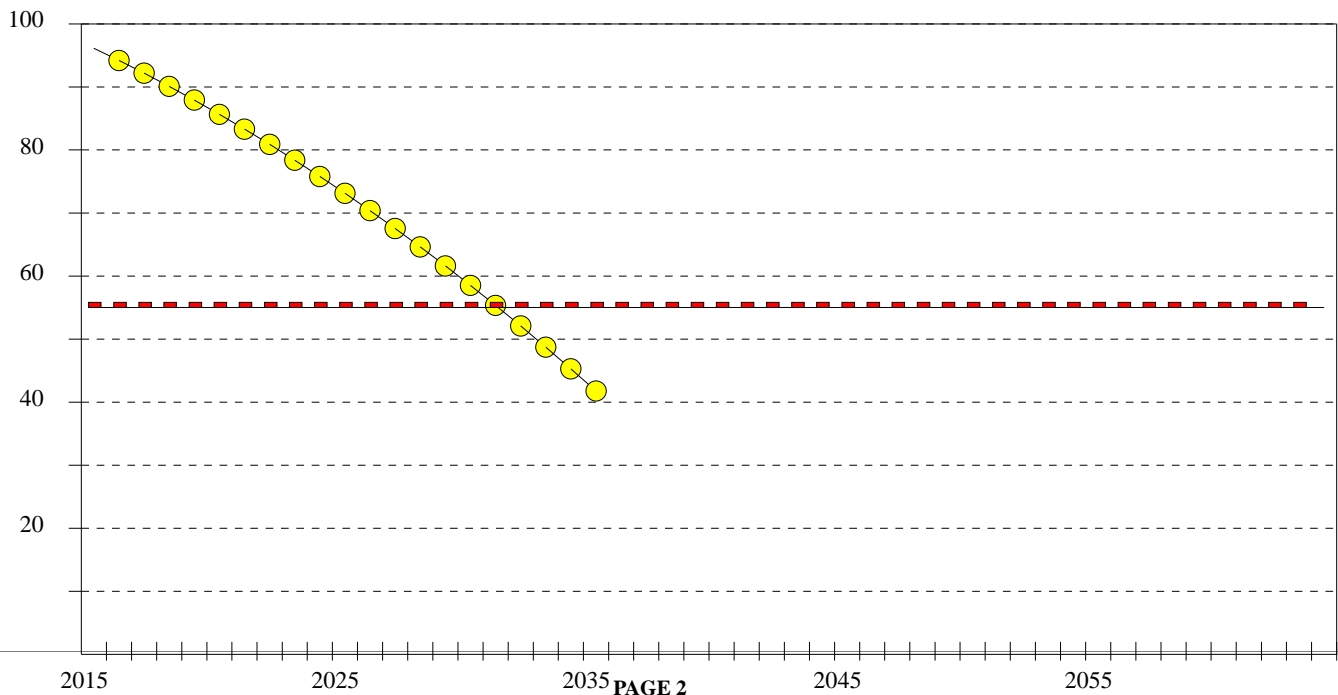

AIRPORT: INDIANAPOLIS DOWNTOWN HELIPORT

AIRPAV FEATURE ANALYSIS PROGRAM OUTPUT

FEATURE: 3020	DESCRIPTION: RAMP
ANALYSIS YEAR: 2015	INSPECTION DATE: 10-24-14
PAVEMENT TYPE: PCC	FEATURE'S HIGH PCI: 100
FEATURE AREA: 6,400	FEATURE'S LOW PCI: 99
INSPECTED AREA: 5,795	AVERAGE PCI: 100 GOOD
MINIMUM SERVICE LEVEL: 55	ESTIMATED PCI IS: 99 in 2015

COMMENTS/HISTORY FOR FEATURE 3020, RAMP

1993 UNKNOWN P501 SECTION

*
*
*

DISTRESS QUANTITIES FOR FEATURE 3020

DISTRESS TYPE	SEVERITY	MEASURED QUANTITY	ESTIMATED TOTAL QUANTITY	UNITS	PERCENTAGE OF All DISTRESS
PATCH<5 SF	LOW	1	1	SLABS	100

BASIC DISTRESS CAUSES

APPROXIMATE AMOUNT OF DISTRESS RELATED TO LOAD ON THE PAVEMENT IS:	0 %
APPROXIMATE AMOUNT OF DISTRESS RELATED TO MATERIALS PROBLEMS IN THE FEATURE IS:	67 %
APPROXIMATE AMOUNT OF DISTRESS RELATED TO AGE OF PAVEMENT AND TRAFFIC REPETITIONS IS:	33 %



AIRPORT: INDIANAPOLIS DOWNTOWN HELIPORT

AIRPAV FEATURE ANALYSIS PROGRAM OUTPUT

FEATURE: 3020

DESCRIPTION: RAMP

ANALYSIS YEAR: 2015

INSPECTION DATE: 10-24-14

PAVEMENT TYPE: PCC

AVERAGE PCI AT INSPECTION: 100 GOOD

CONSTRUCTION YEAR: 1993

ESTIMATED PCI IS: 99 in 2015

MINIMUM SERVICE LEVEL: 55

NORMAL PCI FOR THIS AGE: 73

THE FOLLOWING PROJECTS HAVE BEEN SELECTED AS VIABLE ALTERNATIVES

LEGEND	DESCRIPTION	COST	LIFE EXTENSION
●	NO ACTION	N/A	N/A
-	MINIMUM SERVICE LEVEL, CURRENTLY 55		

PROJECTED PERFORMANCE

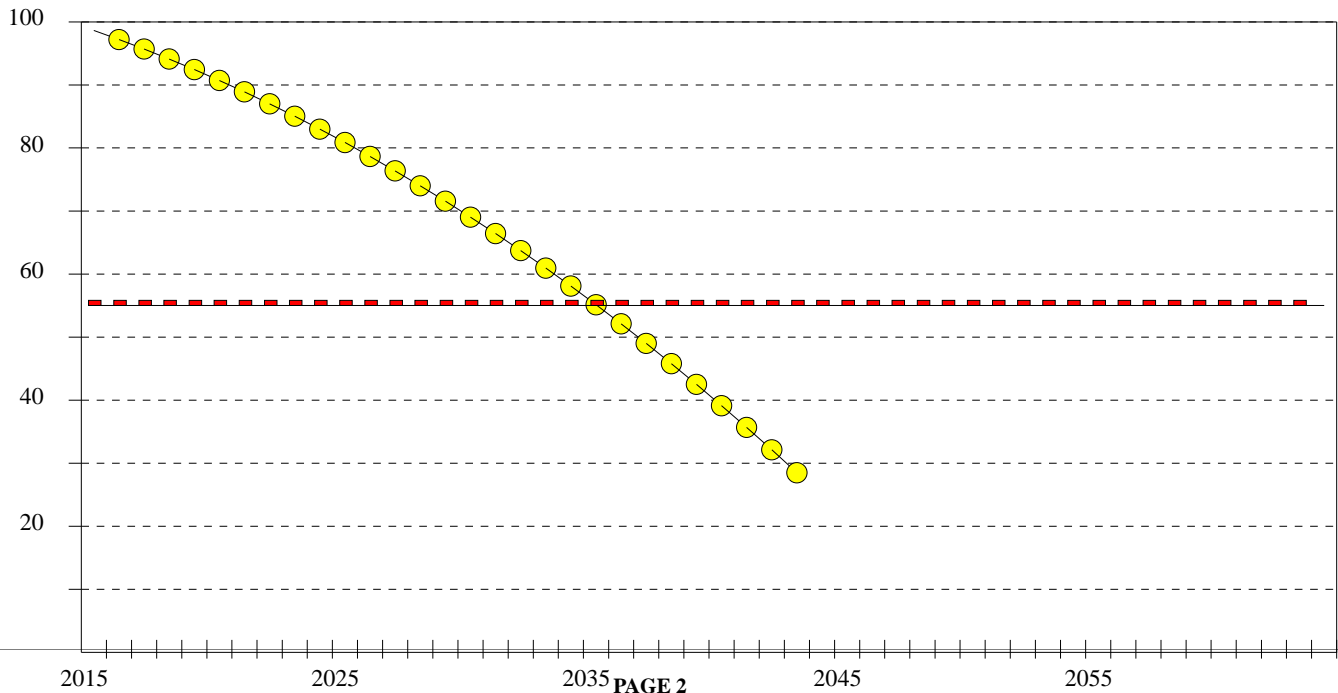

Appendix F. Airport Responsibilities

Grant Assurances

In 1995, Congress mandated that the FAA require, as a condition of grant funding, that airport sponsors prepare documentation of a maintenance management program on pavement that has been constructed, reconstructed, or repaired with Federal assistance.

This report fulfills many of the grant assurance requirements, including documenting:

- Locating all runways, taxiways, and aprons.
- Documenting pavement dimensions.
- Documenting types of pavement.
- Documenting year of construction or most recent major rehabilitation.

The airport owners must be an active participant in maintaining compliance. Actions taken to ensure compliance include:

- Annotating areas constructed or repaired with Federal aid.
- Conducting monthly drive-by inspections to detect changes in pavement condition.
- Recording each drive-by inspection and any maintenance performed as a result.
- Keeping complete records of all maintenance activities.
- Keeping records for 5 years.
- Documenting detailed inspection information with a history of recorded pavement deterioration by PCI survey (e.g., this report).

ASSURANCES Airport Sponsors	
A. General.	<ol style="list-style-type: none"> 1. These assurances shall be complied with in the performance of grant agreements for airport development, airport planning, and noise compatibility program grants for airport sponsors. 2. These assurances are required to be submitted as part of the project application by sponsors requesting funds under the provisions of Title 49, U.S.C., subtitle VII, as amended. As used herein, the term "public agency sponsor" means a public agency with control of a public-use airport; the term "private sponsor" means a private owner of a public-use airport; and the term "sponsor" includes both public agency sponsors and private sponsors. 3. Upon acceptance of the grant offer by the sponsor, these assurances are incorporated in and become part of the grant agreement.
B. Duration and Applicability.	<ol style="list-style-type: none"> 1. Airport development or Noise Compatibility Program Projects Undertaken by a Public Agency Sponsor. The terms, conditions and assurances of the grant agreement shall remain in full force and effect throughout the useful life of the facilities developed or equipment acquired for an airport development or noise compatibility program project, or throughout the useful life of the project items installed within a facility under a noise compatibility program project, but in any event not to exceed twenty (20) years from the date of acceptance of a grant offer of Federal funds for the project. However, there shall be no limit on the duration of the assurances regarding Exclusive Rights and Airport Revenue so long as the airport is used as an airport. There shall be no limit on the duration of the terms, conditions, and assurances with respect to real property acquired with federal funds. Furthermore, the duration of the Civil Rights assurance shall be specified in the assurances. 2. Airport Development or Noise Compatibility Projects Undertaken by a Private Sponsor. The preceding paragraph 1 also applies to a private sponsor except that the useful life of project items installed within a facility or the useful life of the facilities developed or equipment acquired under an airport development or noise compatibility program project shall be no less than ten (10) years from the date of acceptance of Federal aid for the project. 3. Airport Planning Undertaken by a Sponsor. Unless otherwise specified in the grant agreement, only Assurances 1, 2, 3, 5, 6, 13, 18, 30, 32, 33, and 34 in section C apply to planning projects. The terms, conditions, and assurances of the grant agreement shall remain in full force and effect during the life of the project.
C. Sponsor Certification.	<p>The sponsor hereby assures and certifies, with respect to this grant that:</p> <ol style="list-style-type: none"> 1. General Federal Requirements. It will comply with all applicable Federal laws, regulations, executive orders, policies, guidelines, and requirements as they relate to the application, acceptance and use of Federal funds for this project including but not limited to the following: <ul style="list-style-type: none"> Federal Legislation a. Title 49, U.S.C., subtitle VII, as amended. b. Davis-Bacon Act - 40 U.S.C. 276(a), <i>et seq.</i>¹ c. Federal Fair Labor Standards Act - 29 U.S.C. 201, <i>et seq.</i> d. Hatch Act - 5 U.S.C. 1501, <i>et seq.</i>²
<hr/> <small>Airport Assurances (3/2005)</small>	

The table on the following pages is available for maintaining a record of drive-by inspections and maintenance repairs.

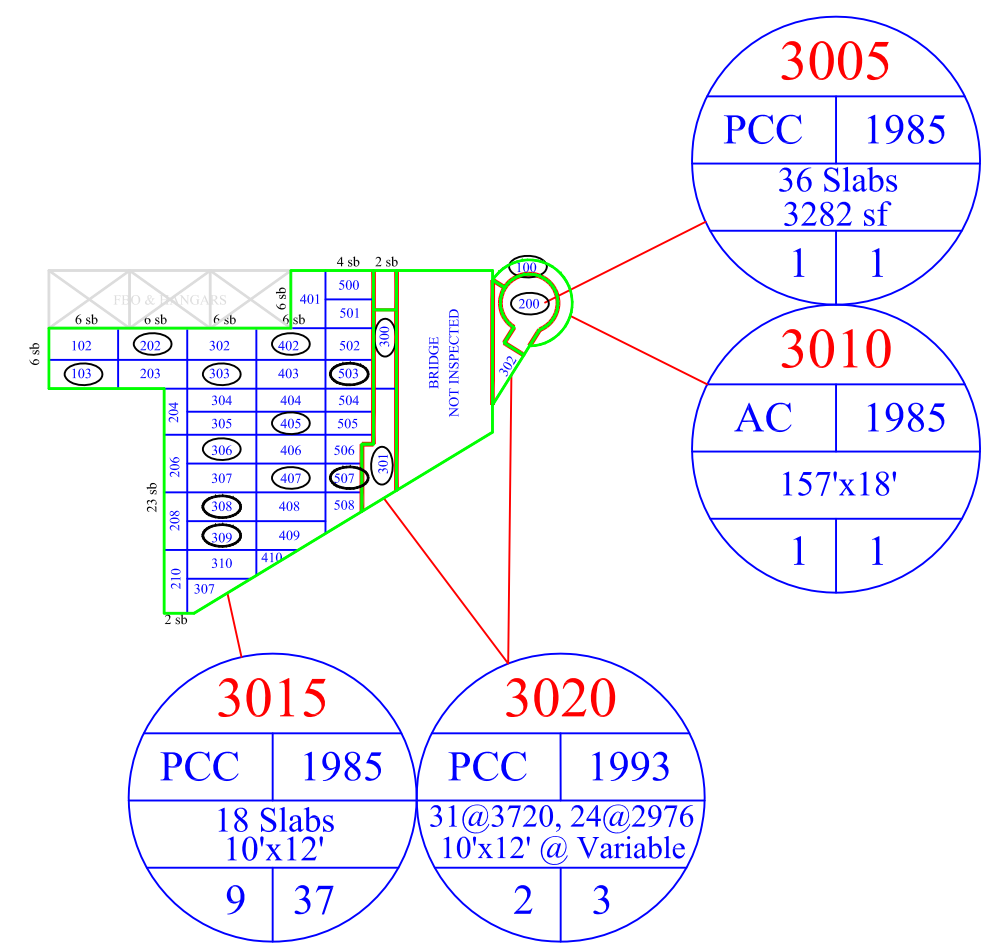
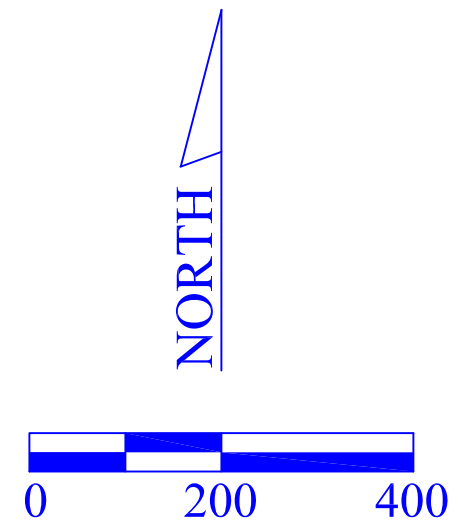

	2011 Update	
	2008 Build	JB
Rev.	Description	By
PCI Inspection Map		
Indiana Dept. of Transportation Indianapolis Downtown Heliport (8A4) Indianapolis, IN 122.8		
	Page: 1/1	