

**ELEVATION - TRANSITION CONNECTION**

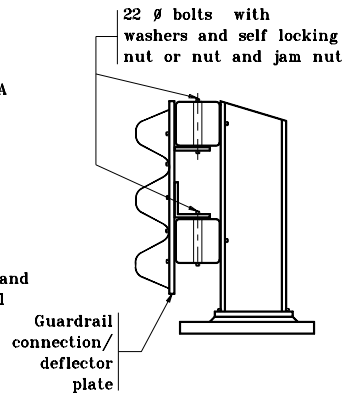

**SECTION C - C**

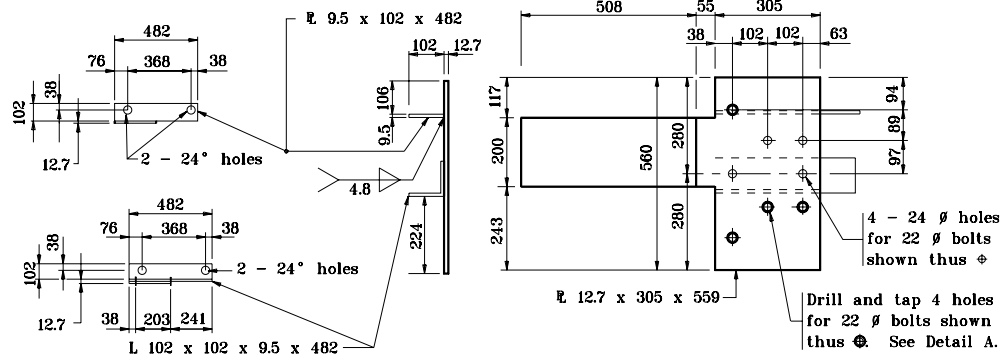

**GUARDRAIL CONNECTION/DEFLECTOR PLATE DETAILS**

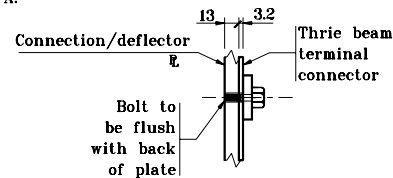
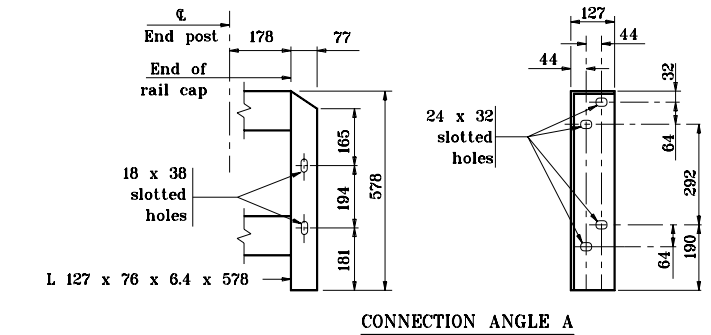
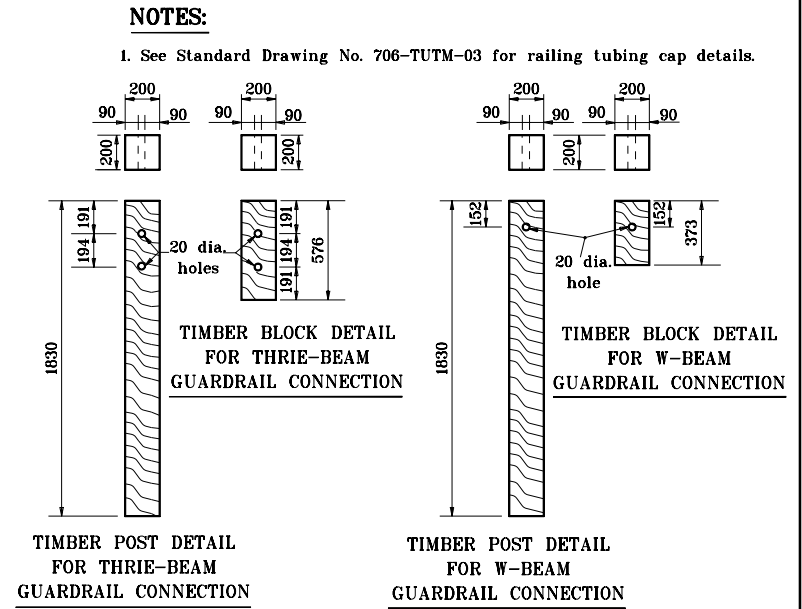
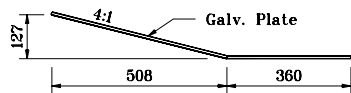

**DETAIL A**

All dimensions are in mm unless otherwise specified.

INDIANA DEPARTMENT OF TRANSPORTATION

**GUARDRAIL TRANSITION, TGT**

MAY 2000

STANDARD DRAWING NO. **601-TTGT-02**

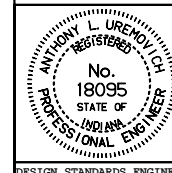

/s/ Anthony L. Uremovich 5-01-00  
DESIGN STANDARDS ENGINEER DATE

/s/ Firooz Zandi 5-01-00  
CHIEF HIGHWAY ENGINEER DATE

DESIGN STANDARDS ENGINEER