

FRONT VIEW

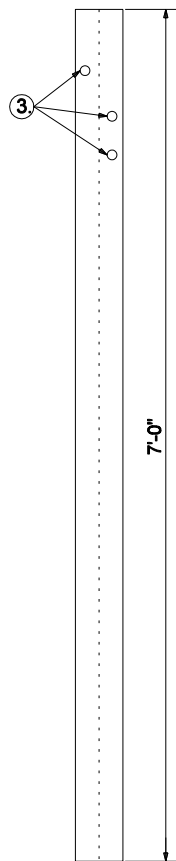

BACK VIEW

W 6 x 9 POST DETAILS

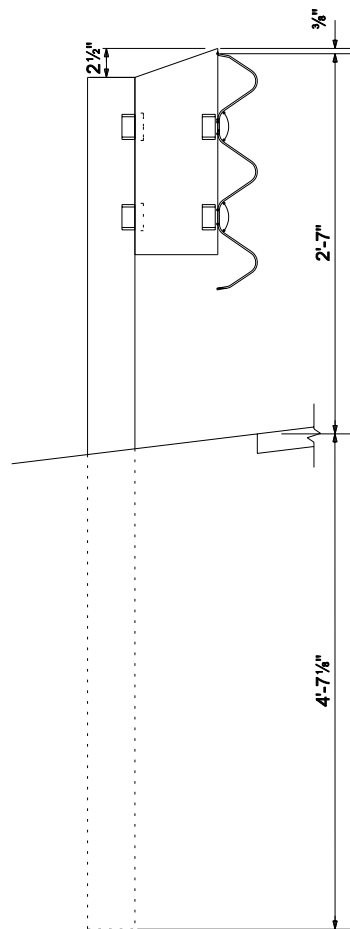

SIDE VIEW

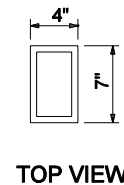

TOP VIEW

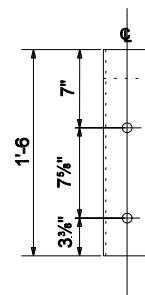

FRONT VIEW

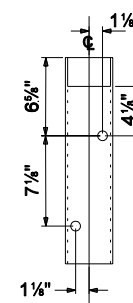

BACK VIEW

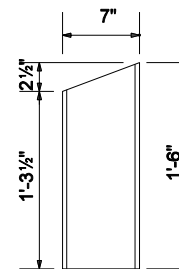

SIDE VIEW

TS 7 x 4 x 3/16" BLOCK DETAILS

POSTS 1 THRU 7

NOTE:

1. All holes drilled or punched to 3/4" dia.
2. For post numbers see Standard Drawing E601-TTGB-01.
- ③ Hole pattern for posts numbers 8 thru 10 may be drilled in back flange. See Standard drawing E 601-TTGB-04 or E 601-TTGB-05.

INDIANA DEPARTMENT OF TRANSPORTATION

**GUARDRAIL TRANSITION
TYPE TGB**

MARCH 2004

STANDARD DRAWING NO. E 601-TTGB-03

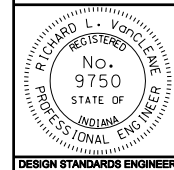

/s/ Richard L. VanCleave 3-01-04
DESIGN STANDARDS ENGINEER DATE

/s/ Richard K. Smutzer 3-01-04
CHIEF HIGHWAY ENGINEER DATE

DESIGN STANDARDS ENGINEER