

GENERAL NOTES

1. This sheet shall be used in conjunction with Standard Drawing Nos. E 724-BSSJ-05 through 09.
2. Allowable expansion lengths shall not be increased for skewed structures.
- ③ Tool concrete edges to $\frac{1}{4}$ " to $\frac{3}{8}$ " radius.
- ④ Anchors shall be spaced at 9 in.

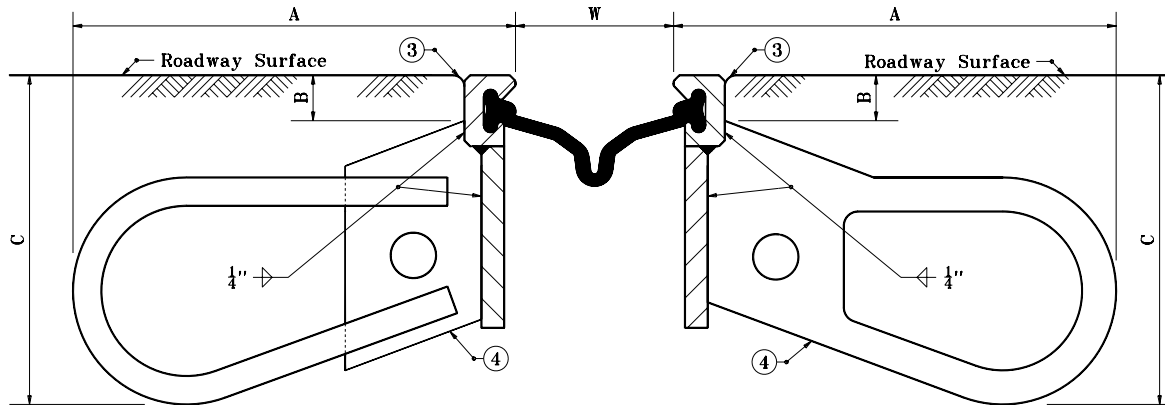

INSTALLATION DETAIL

DIMENSIONS

ALTERNATES	A	B	C
A-1	9 $\frac{3}{4}$ "	1"	7 $\frac{1}{4}$ "
A-2			
B-1	9 $\frac{3}{4}$ "	1 $\frac{5}{8}$ "	7 $\frac{1}{8}$ "
B-2			
C-1	9 $\frac{3}{4}$ "	1 $\frac{13}{16}$ "	7 $\frac{1}{4}$ "
C-2			
D-1	9 $\frac{3}{4}$ "	1"	7 $\frac{5}{8}$ "
D-2			

JOINT SETTING TABLE

Ambient Temperature °F	DIMENSION "W"		
	Expansion Length		
	100'-200'	200'-300'	300'-400'
120°	2 $\frac{1}{8}$ "	1 $\frac{5}{8}$ "	$\frac{1}{2}$ "
100°	2 $\frac{7}{16}$ "	1 $\frac{3}{4}$ "	1 $\frac{1}{8}$ "
80°	2 $\frac{11}{16}$ "	2 $\frac{3}{8}$ "	1 $\frac{11}{16}$ "
60°	3"	2 $\frac{5}{8}$ "	2 $\frac{1}{4}$ "
40°	3 $\frac{5}{8}$ "	3 $\frac{1}{8}$ "	2 $\frac{13}{16}$ "
20°	3 $\frac{9}{8}$ "	3 $\frac{1}{2}$ "	3 $\frac{3}{8}$ "
0°	3 $\frac{7}{8}$ "	3 $\frac{1}{8}$ "	4"

INDIANA DEPARTMENT OF TRANSPORTATION

EXPANSION JOINTS

CLASS SS

JUNE 1996

STANDARD DRAWING NO. E 724-BSSJ-04

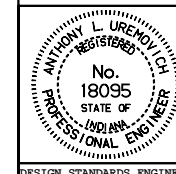

DETAILS PLACED IN THIS FORMAT 11-15-99

/s/ Anthony L. Uremovich 11-15-99
DESIGN STANDARDS ENGINEER DATE

/s/ Firooz Zandi 11-15-99
CHIEF HIGHWAY ENGINEER DATE

DESIGN STANDARDS ENGINEER

ORIGINALLY APPROVED 6-03-96